

## TABLE OF CONTENTS

<b>1. INTRODUCTION .....</b>	<b>5</b>
<b>WELCOME .....</b>	<b>5</b>
About the Owner's Manual.....	5
Reading the manual in Adobe Acrobat Reader.....	5
<b>CLAVIA ON THE INTERNET .....</b>	<b>6</b>
<b>2. OVERVIEW .....</b>	<b>7</b>
<b>THE NORD ELECTRO 2 FRONT PANEL .....</b>	<b>7</b>
The left panel section.....	7
The Organ section .....	8
The Instrument Select button .....	8
The Piano section .....	8
The Effects section.....	8
The Keyboard.....	8
<b>NORD ELECTRO 2 REAR PANEL .....</b>	<b>9</b>
Connections.....	9
<b>NORD ELECTRO 2 BLOCK DIAGRAM.....</b>	<b>11</b>
<b>3. GETTING STARTED.....</b>	<b>12</b>
<b>SELECTING PROGRAMS .....</b>	<b>12</b>
<b>OCTAVE SHIFT.....</b>	<b>12</b>
<b>TRANSPOSE .....</b>	<b>13</b>
<b>SETTING VELOCITY SENSITIVITY FOR THE PIANOS.....</b>	<b>13</b>
<b>USING A SUSTAIN PEDAL .....</b>	<b>13</b>
Setting up the sustain pedal polarity .....	14
Setting up the sustain pedal configuration.....	14
<b>USING A ROTOR SPEED SWITCH PEDAL .....</b>	<b>14</b>
<b>USING A CONTROL (EXPRESSION) PEDAL.....</b>	<b>15</b>
<b>BASIC MIDI SETTINGS .....</b>	<b>15</b>
<b>4. EDITING PROGRAMS.....</b>	<b>16</b>
<b>WHAT'S A PROGRAM? .....</b>	<b>16</b>
<b>EDITING A PROGRAM.....</b>	<b>16</b>
The knobs.....	16
The buttons.....	16
Selecting instrument (Organ or Piano).....	17
<b>REVERTING TO THE ORIGINAL PROGRAM .....</b>	<b>17</b>
<b>STORING A PROGRAM .....</b>	<b>17</b>
<b>COPYING PROGRAMS.....</b>	<b>18</b>

<b>DELETING PROGRAMS .....</b>	<b>18</b>
<b>DOWNLOADING PROGRAMS VIA MIDI.....</b>	<b>18</b>
<b>5. PANEL REFERENCE .....</b>	<b>19</b>
<b>THE ORGAN SECTION.....</b>	<b>19</b>
The Drawbars .....	20
Drawbar presets.....	20
User Drawbar presets.....	21
Percussion.....	21
Vibrato .....	22
Manual .....	22
Swell control (from expression pedal) .....	23
Rotary Speaker.....	23
Key click control.....	24
Output routing (hard pan).....	24
<b>THE PIANO SECTION .....</b>	<b>25</b>
Type .....	25
Presence.....	26
Presence with the Mega Clavinet sound .....	26
Output routing (hard pan).....	27
Velocity Sensitivity for the Pianos .....	27
<b>THE EFFECTS SECTION .....</b>	<b>28</b>
Modulations.....	29
Effects.....	31
Overdrive.....	31
Rotary Speaker.....	31
Output Level .....	32
Treble & Bass.....	32
<b>THE LEFT PANEL SECTION .....</b>	<b>32</b>
Master Level .....	32
Navigator buttons.....	32
Display .....	32
Store .....	33
Program buttons.....	33
Octave Shift.....	33
The Shift button .....	33

<b>SYSTEM FUNCTIONS .....</b>	<b>33</b>
MIDI Ch .....	34
Lower Ch.....	34
Local.....	34
Tune.....	35
Mem Lock .....	35
Transpose .....	36
Ped. Pol.....	36
Config .....	36
Key click control.....	37
Output routing (hard pan).....	37
Velocity Sensitivity for the Pianos .....	38
Leslie acceleration rate .....	38
Dump.....	39
Panic .....	39
<b>6. FACTORY PRESETS AND OS.....</b>	<b>40</b>
<b>INTERNAL MEMORY.....</b>	<b>40</b>
<b>FACTORY PRESETS.....</b>	<b>40</b>
Restoring the factory presets .....	40
<b>DOWNLOADING PIANO INSTRUMENTS VIA USB.....</b>	<b>40</b>
<b>OS UPGRADES.....</b>	<b>40</b>
<b>7. MIDI FUNCTIONS .....</b>	<b>41</b>
<b>ABOUT THE MIDI IMPLEMENTATION .....</b>	<b>41</b>
Note On/Off.....	41
Pitch Bend.....	41
Controllers.....	41
Keyboard Velocity .....	41
Program Change.....	41
MIDI Sysex (System Exclusive) .....	42
<b>USING NORD ELECTRO 2 WITH A SEQUENCER .....</b>	<b>42</b>
Connections .....	42
Local On/Off .....	42
MIDI channel.....	42
Program Change.....	42
Controllers.....	42
Some notes about Controllers and “Chasing” .....	42
<b>PROGRAM AND CONTROLLER DUMPS .....</b>	<b>43</b>
Receive MIDI Sysex Dumps.....	44
<b>8. MIDI IMPLEMENTATION .....</b>	<b>45</b>
<b>MIDI CONTROLLER LIST.....</b>	<b>45</b>
<b>MIDI IMPLEMENTATION CHART.....</b>	<b>48</b>

**9. HISTORY ..... 49**

**THE STORY BEHIND THE ELECTRO 2 INSTRUMENTS .....49**

    What is an 'electromechanical' instrument? .....49

    How does an electromechanical pick-up work? .....49

    The Electro 2 organ section..... 50

    The Wurlitzer EP ..... 55

    The Hohner Clavinet ..... 57

    Book suggestions ..... 59

    Web suggestions..... 59

    Music suggestions ..... 59

**INDEX ..... 61**

# 1. INTRODUCTION

## WELCOME

We'd first like to thank you for purchasing the Nord Electro 2 - Virtual Electromechanical stage keyboard. Clavia's goal when developing the Nord Electro instrument was to create the best emulations of traditional electromechanical keyboard instruments on the market, and to make the instrument compact and light-weight. Nothing else. No brass banks, no orchestral sounds. No compromises. Just outstanding electromechanical keyboard sounds with true feel, from natural keyboard response to authentic sound. To make a great tool you have to put all the focus on a few things, and that's what we did with the Electro. Think about it, the *best* tool isn't a Swiss army knife.

The organ section in the Electro is based on a digital simulation of the mechanical tone wheels of the B-3 organ. It offers innovative solutions to mimic the typical B-3 sound, for example:

- An extremely accurate digital model of the original chorus and vibrato scanner.
- Modeling of the individual random contact bounces for each partial.
- Modeling of the unique frequency characteristics of the built-in pre-amplifier which forms the "body" of the B-3 sound.
- Simulation of the energy stealth on the tone wheels that results in the typical "compressed" sound.

The piano section in Nord Electro 2 OS V3.0 comprises five carefully multi-sampled electric piano instruments: Clavinet D6, Wurlitzer 200A, Electric Piano Mk I Stage Piano, a Electric Piano Mk I Suitcase Piano with a brighter sound and the custom modified Clavia Electric Grand Model G. The Electro features a unique multi-sample playback, catching every nuance from soft to hard key strokes. Nord Electro comes right out of the box with these five electric piano sounds stored in Flash memory. As an extra bonus we also included an acoustic grand piano (concert model) - in stereo! The big advantage with Flash memory is that you can replace instruments with new ones and that no backup battery is required. The Electro also sports a USB interface for quick and easy download of new piano sounds. On the CD-R that comes with the Electro 2 there are additional Piano sounds. Also available at <http://www.clavia.se>.

## ABOUT THE OWNER'S MANUAL

The manual is arranged mainly as a reference manual. In many cases you'll get tips on how to practically use the functions, alone and also together with other functions. Every time the manual wants your attention to an object on the Electro, the name of that object will be printed **LIKE THIS**, e.g. 'press the **STORE** button'. The LED display on Nord Electro is always referred to as the **DISPLAY**. Whenever there is a reference to the 'keyboard', that reference also applies to any incoming MIDI note messages.

## READING THE MANUAL IN ADOBE ACROBAT READER

This manual is also available in the digital PDF-file format. It can be downloaded, free of charge, from Clavia's web site at <http://www.clavia.se>. When reading the manual as PDF-file, you will need Adobe Acrobat Reader 4.0 or later. This program can be downloaded, free of charge, at <http://www.adobe.com>.

With Adobe Acrobat Reader it is possible to use special navigation features like hyperlinks. This means that you can click with the mouse on a word or sentence and automatically get to the location indicated by the word/sentence. To better show what words or sentences are hyperlinked in this manual, these words are written in **magenta**.

## **CLAVIA ON THE INTERNET**

If you have access to the Internet, you're very welcome to visit <http://www.clavia.se>. There you will find the latest information about Nord Electro 2 and other Clavia products. In the future you'll also be able to download new Nord Electro sounds and software upgrades, free of charge.

## 2. OVERVIEW

### THE NORD ELECTRO 2 FRONT PANEL

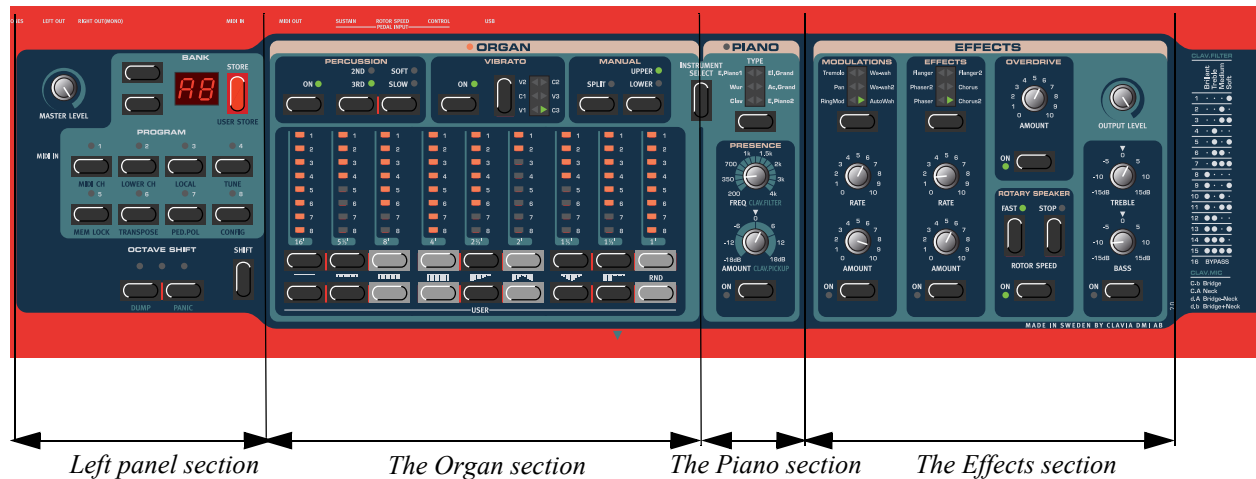

### THE LEFT PANEL SECTION

#### MASTER LEVEL

The **MASTER LEVEL** knob controls the output level from the two **OUT** jacks and the **HEADPHONES** output. **The MASTER LEVEL knob does not send or receive any MIDI CC# but is used to control the entire instrument's output level.** (For info on how to control the level of an individual Program and via MIDI, please refer to [“Output Level” on page 32](#)).

#### NAVIGATOR BUTTONS AND DISPLAY

To the right of the **MASTER LEVEL** knob are two buttons, the **NAVIGATOR** buttons. These are used to select Program Banks (A-F) and various system functions. To the right of the **NAVIGATOR** buttons is the **DISPLAY**. It's used to display Program Banks and also various system parameters.

#### THE STORE BUTTON

To the right of the **DISPLAY** is the red **STORE** button. This is used when storing Programs (see [“Storing a Program” on page 17](#)) and also when executing various system commands.

#### PROGRAM BUTTONS

Below the **DISPLAY** are the eight **PROGRAM** buttons (**1 - 8**). Use them to select Programs and to select various system functions.

#### THE SHIFT BUTTON

Below the **PROGRAM** buttons is the **SHIFT** button. It's used to access various kinds of system functions etc.

#### OCTAVE SHIFT BUTTONS

These buttons are used to transpose the notes +/- 2 octaves (if the selected instrument supports this).

## THE ORGAN SECTION

The Organ section comprises four sub sections: the Percussion section, the Vibrato/Chorus section, the Manual section and the Drawbar section. The nine drawbars of Nord Electro are represented by up/down buttons and LED chain graphs instead of ordinary mechanical drawbars. This gives you a big advantage: when you change presets, the correct drawbar settings are shown immediately by the LEDs. In other words, no need for the regular 'trial and error' method.

## THE INSTRUMENT SELECT BUTTON

Inbetween the Organ and Piano sections is the **INSTRUMENT SELECT** button. Press this button to select the Organ section or Piano section.

## THE PIANO SECTION

The Piano sections consists of two sub sections: the instrument Type section and the Presence section. With the **TYPE** button you select the Piano instrument to use and with the Presence parameters you can add parametric equalization to your piano sound. With the V2.X Mega Clavinet D6 sound the Presence parameters act as filter and pick-up selectors (see [“Presence with the Mega Clavinet sound”](#) on page 26)

## THE EFFECTS SECTION

Here you'll find the numerous effects and modulations you could use to add that extra flavour to your sounds. The Effects section also features a tube type Overdrive distortion, Rotary Speaker simulation and a Treble & Bass EQ. Here you'll also find the **OUTPUT LEVEL** control which is the volume control for each individual Program.

## THE KEYBOARD

The keyboard of Nord Electro is either 5 octaves (Nord Electro SixtyOne) or 6 octaves (Nord Electro SeventyThree). Both versions feature the specially designed, semiweighted, velocity sensitive “waterfall” (square front) keyboard for optimal feel and response. The semiweighted action is ideal for use with both Organ and Piano sounds. The keyboard also sends Keyboard Velocity over MIDI.



## NORD ELECTRO 2 REAR PANEL

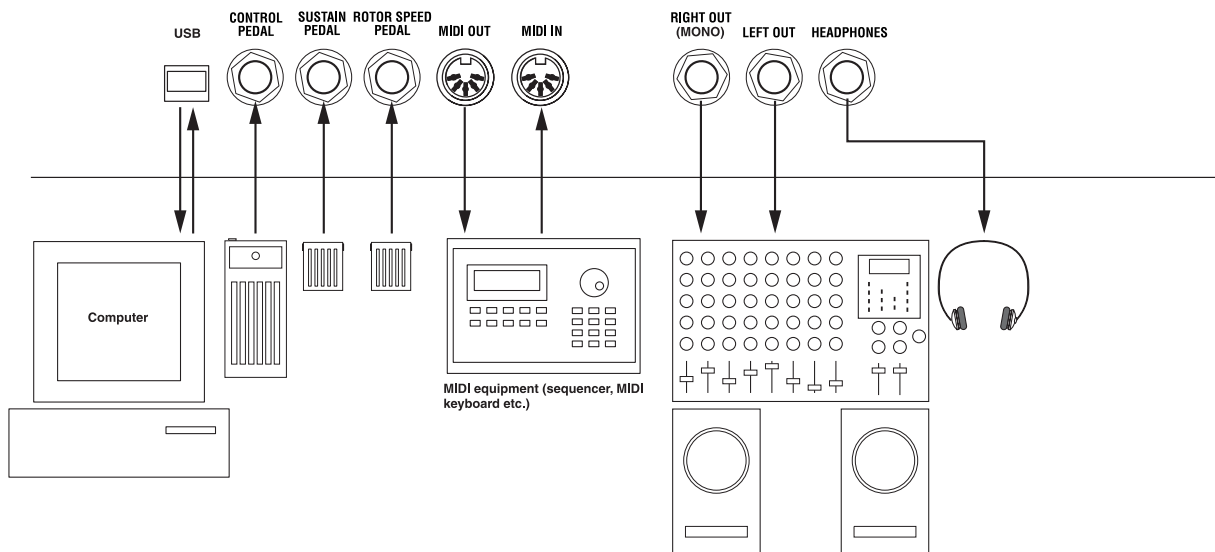

### CONNECTIONS

- Make all connections before turning on your power amplifier!
- If you are using a Nord Electro 2 together with a MIDI keyboard, connect a MIDI cable from MIDI Out on the keyboard to **MIDI IN** on the Nord Electro 2.
- All signal cables used with the Nord Electro must be shielded.
- The two audio outputs (**LEFT OUT** and **RIGHT OUT**) are line level and unbalanced. If you want the sum of the signals on one separate output only, use **RIGHT OUT**.
- If you connect the Nord Electro 2 in stereo to your audio equipment, you should use **LEFT OUT** in pair with **RIGHT OUT**.
- If you choose the option to route Organ sounds and Piano sounds to a separate output each (see [“Output routing \(hard pan\)”](#) on page 37), the **RIGHT OUT** is for the Piano sound and the **LEFT OUT** for the Organ sound.

### CONNECTING PEDALS

The Nord Electro 2 has three pedal inputs, one **CONTROL PEDAL** input (for controlling Organ Swell or Wah-Wah), one **SUSTAIN PEDAL** input (sustain) and one **ROTOR SPEED** input (for rotary speaker fast/slow selection). Connect the pedals as shown in the figure below:

When connecting an expression-type pedal to the **CONTROL PEDAL** input, you should use a stereo cable (Tip-Ring-Sleeve). Please note that the pedal must have a stereo output jack. The resistance range of the Control Pedal should be 0 to between 10 kOhm and 50 kOhm. Pedals like the Roland EV-5 and control/expression pedals from Proel works well with the Electro 2. Control/Expression pedals from Yamaha have different characteristics and are not suitable for use with the Electro 2.

It's also possible to use only one single Sustain pedal connected to the **SUSTAIN PEDAL** input to control sustain for Piano sounds and Rotary Speaker speed selection for organ sounds (see [page 14](#) for details on how to configure this).

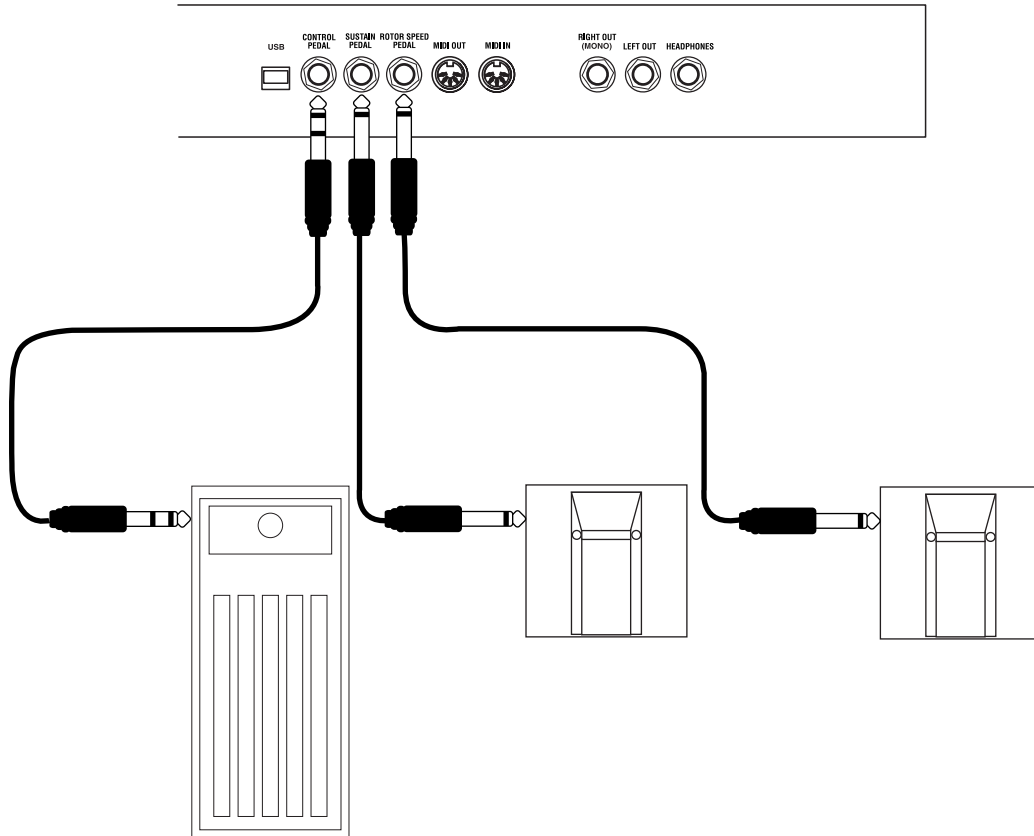

(For more detailed information on how to set up Nord Electro 2 for use with sustain and expression pedals, see [page 13](#)).

## NORD ELECTRO 2 BLOCK DIAGRAM

Below is a schematic overview of the sound and modulation building blocks and the signal flows in Nord Electro 2. The filled lines indicate audio signal routings and the dashed black lines control signal routings. The '/2' sign printed next to some filled lines indicates that the signal is/can be in stereo. The circles with a '+' sign inside indicates that any input stereo signals will be summarized into a mono signal before routed to the specific effect. For example, the V2.X stereo Acoustic Grand will be in mono if you apply any effect except for the Pan, Tremolo or EQ.

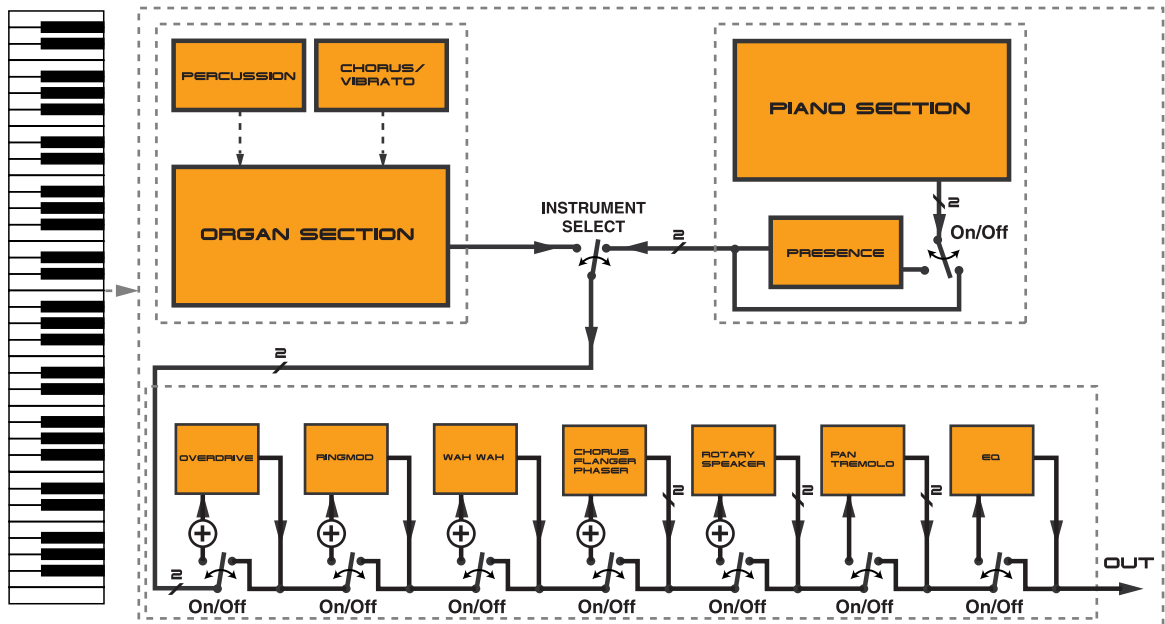

As you can see, the internal configuration of Nord Electro 2 is pretty straight-forward, yet very powerful and flexible. Each of the building blocks also offers possibilities for internal configurations. This is described in detail in [Chapter "5. Panel reference" on page 19](#).

## 3. GETTING STARTED

### SELECTING PROGRAMS

Programs are single sounds that are stored in the internal memory of Nord Electro 2. The Program memory in Nord Electro 2 consists of 6 Banks each holding 8 Programs for a total of 48 Programs. All Programs can be edited and replaced at any time. To select a Program for playing/editing, do like this:

1. Select Bank (A-F) by pressing the **UP/DOWN NAVIGATOR** buttons if you want to change Bank.
2. Select Program by pressing one of the eight **PROGRAM** buttons 1 to 8.

*Press the **UP** or **DOWN NAVIGATOR** buttons to select Program Bank A-F.*

*Press one of the eight **PROGRAM** buttons to select a Program to play. The corresponding LED will light up.*



### OCTAVE SHIFT

The two **OCTAVE SHIFT** buttons to the bottom left on the front panel can be used to transpose the notes two octaves up or down (if the selected instrument supports this). A flashing **OCTAVE SHIFT LED** indicates +/- 2 octaves note shift.

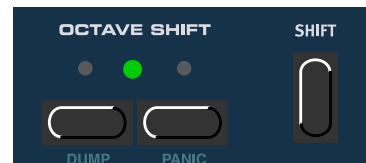

**Note:** Due to the actual key range of the original Piano instruments, some sounds cannot be octave shifted up and/or down. For organ sounds, the Octave Shift will only generate notes that are within the 73-key note range of Nord Electro 2 73. This means that using Octave Shift for Organ sounds in Nord Electro 2 73 won't produce any sound in the lowest or highest octave.

## TRANPOSE

It's also possible to transpose a sound up or down in semitone steps. Press the **SHIFT + PROGRAM 6 (TRANSPOSE)** buttons. The **DISPLAY** reads '0'. Press the **UP/DOWN NAVIGATOR** buttons to transpose the sound up or down in semitone steps. The range is +/- 6 semitones in steps of 1 semitone. Press any button (except for the **SHIFT, STORE** or **UP/DOWN** buttons) to exit.

**Note: Due to the actual key range of the original Piano instruments, the lowest keys may not produce any sound when transposed down. The same goes for the highest keys when the instrument is transposed up. For organ sounds, the Transpose function will only generate notes that are within the 73-key note range of Nord Electro 2 73. This means that using the Transpose function for Organ sounds in Nord Electro 2 73 will cause the lowest or highest notes of the keyboard to be silent.**



## SETTING VELOCITY SENSITIVITY FOR THE PIANOS

Some of the piano instruments sampled for the Nord Electro 2 have very wide dynamic ranges by nature and naturally we wanted to capture this as accurately as possible. Therefore, it could be perceived that it is a little hard to reach the most extreme levels when playing the Nord Electro 2 piano sounds with the default keyboard Velocity Sensitivity setting. This is because the dynamic response curves have been very carefully adjusted to match each original instrument's response characteristics. In other words, Clavia's intention was that when you play a Electric Piano sound, for example, it should almost feel like you are playing a Electric Piano. However, If you want the piano sounds to respond more easily to keyboard velocity, you can set this in the Config menu. The Velocity Sensitivity setting is global for all Pianos in the Electro 2.

1. Hold **SHIFT** and press the **PROGRAM 8 (CONFIG)** button four times. The **DISPLAY** reads 'U.0' (Velocity Sensitivity).
2. Change the Velocity Sensitivity between 'U.0' (least sensitive) and 'U.9' (most sensitive) with the **UP/DOWN NAVIGATOR** buttons.
3. Press any button (except for the **SHIFT, STORE** or **UP/DOWN** buttons) to exit.



## USING A SUSTAIN PEDAL

A foot switch connected to the **SUSTAIN PEDAL** input can be set to act in two different ways:

- As a sustain pedal for both the Piano and Organ sounds (see Sustain Pedal Configuration below)

- As a sustain pedal for Piano sounds and as a Rotor Speed switch for the Organ sounds (see Sustain Pedal Configuration below)

### SETTING UP THE SUSTAIN PEDAL POLARITY

Set up the pedal polarity as follows:

1. Press the **SHIFT + PROGRAM 7 (PED.POL)** buttons. The **DISPLAY** reads 'CL' or 'OP'.
2. Change sustain pedal polarity between 'OP' (Open) (open when pressed) and 'CL' (Closed) (closed when pressed) with the **UP/DOWN NAVIGATOR** buttons.
3. Press any button (except for the **SHIFT, STORE** or **UP/DOWN** buttons) to exit.



### SETTING UP THE SUSTAIN PEDAL CONFIGURATION

1. Press the **SHIFT + PROGRAM 8 (CONFIG)** buttons. The **DISPLAY** reads 'P.S' (Pedal Sustain) or 'P.t' (Pedal toggle).
1. Change sustain pedal functionality between 'P.S' (Sustain for both Piano and Organ sounds) and 'P.t' (sustain for Piano sounds and Rotor Speed switch for Organ sounds) with the **UP/DOWN NAVIGATOR** buttons.
2. Press any button (except for the **SHIFT, STORE** or **UP/DOWN** buttons) to exit.



Nord Electro 2 sends and receives Sustain Pedal messages as MIDI (CC# 64). **Note! If you have selected 'P.t', Rotor Speed selection is sent from the sustain pedal as MIDI CC#82 - not CC#64!**

### USING A ROTOR SPEED SWITCH PEDAL

A foot switch connected to the **ROTOR SPEED** input can be used to switch between Slow and Fast rotor speed for the Rotary Speaker effect (see [page 31](#)). Nord Electro 2 will also send and receive Rotor Speed switch messages via MIDI (CC# 82).

**Note: The Pedal Polarity setting that you made for the SUSTAIN PEDAL input (see above) also affects the ROTOR SPEED input.**

## USING A CONTROL (EXPRESSION) PEDAL

As indicated in the illustration on [page 9](#), a regular resistive (range 10 kOhm to 50 kOhm) expression pedal can be connected to the **CONTROL PEDAL** input, using a stereo (Tip-Ring-Sleeve) cable. The connected pedal can be used to control either Organ Swell (the characteristic B3 volume control) or Wah-Wah modulation. Pedals like the Roland EV-5 and control/expression pedals from Proel works well with the Electro 2. Control pedals from Yamaha have different characteristics and are not suitable for use with the Electro 2. Nord Electro 2 will also send and receive Expression pedal messages via MIDI (CC# 11).

## BASIC MIDI SETTINGS

If you are controlling the Nord Electro 2 from an external MIDI keyboard, the Nord Electro 2 must be set to receive on the same MIDI channel that the external keyboard transmits on. Nord Electro 2 is monotimbral (or bitimbral when using the Organ section. See [“Using an additional “Lower Manual” MIDI keyboard” on page 22](#)) which means it can only transmit and receive on one MIDI channel at a time.

1. Set the MIDI keyboard to transmit and receive on MIDI Channel 1. (This is the default setting when Nord Electro 2 is shipped from factory).
2. Press the **SHIFT + PROGRAM 1 (MIDI CH)** buttons. The **DISPLAY** shows the currently selected MIDI channel.
3. Scroll with the **UP/DOWN NAVIGATOR** buttons to select MIDI Channel 1 (if it isn't already selected).
4. Press any button (except for the **SHIFT, STORE** or **UP/DOWN** buttons) to exit.



For information on how to set up Nord Electro 2 for use with an external sequencer, see [“Using Nord Electro 2 with a sequencer” on page 42](#).

## 4. EDITING PROGRAMS

### WHAT'S A PROGRAM?

A Program in Nord Electro 2 consists of a selected Instrument (an Organ sound or a specific Piano sound), the settings you have made for the instrument, e.g. Drawbar, Percussion and Chorus/Vibrato settings for Organ sounds or Presence settings for a Piano sound, Octave Shift settings plus all the settings of the Effects section. For Piano based sounds this means that a Program does **not** contain any samples - only the parameter data that affects the selected Piano type. This is important to bear in mind when performing a MIDI Sysex dump of a Piano based Program (see “Dump” on page 39).

### EDITING A PROGRAM

Actually, how to change a programmed sound can be described in one sentence: “tweak the knobs and press the buttons”. It *is* as simple as that! Don't be afraid to edit and overwrite the factory Programs. If you want to restore any of the original factory programs later, you can fetch them at <http://www.clavia.se> and download to your Nord Electro 2 as MIDI Sysex files. To indicate that a Program has been edited (changed from the stored version), a dot is shown to the right of the Program number in the **DISPLAY**:



### THE KNOBS

All **KNOBS** on the Nord Electro 2 are of potentiometer type. This means that when you begin to edit a Program the values of the parameters can be totally different from the **KNOBS** physical positions. As soon as you begin turning a **KNOB**, the parameter value will ‘snap’ to the **KNOB’S** physical position. This could generate drastic changes to the sound but that's normal.



### THE BUTTONS

There are three types of buttons for editing sounds on the Nord Electro 2:

#### SELECTOR BUTTONS

Press the **SELECTOR** button repeatedly to select between functions printed next to the corresponding triangular LED (see figure to the right).

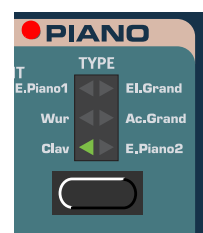

#### ON/OFF BUTTONS

The **ON/OFF** buttons have a LED next to them to indicate the status.

#### DRAWBAR BUTTONS

The **DRAWBAR** buttons are special in the way that they auto-increment/decrement the corresponding parameter when held. I.e. if you hold a **DRAWBAR** button the corresponding drawbar parameter will continue to increment or decrement (within its range) until you release the button.



### SELECTING INSTRUMENT (ORGAN OR PIANO)

No matter what Program you're editing, you could always select a different instrument type at any time. There are two main instrument sections in Nord Electro 2: the Organ section and the Piano section. You switch between these sections by pressing the **INSTRUMENT SELECT** button located between the Organ and Piano sections. When you have selected an instrument section the other section, with its sub groups, is automatically disabled (all its LEDs go blank). However, all settings of the respective groups are memorized so when you switch back, all parameter values of the instrument group are automatically recalled. The parameters of the Effects section will always remain unaffected when you switch instrument group.

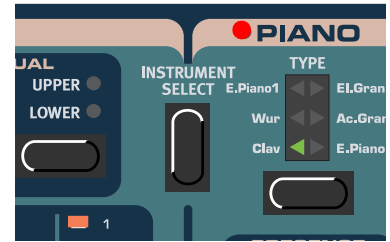

### REVERTING TO THE ORIGINAL PROGRAM

If you have edited a Program and want to revert to the stored original, just press the corresponding **PROGRAM** button again.

### STORING A PROGRAM

Storing a Program will permanently overwrite the existing Program in the selected memory location. Be careful so that you don't accidentally erase a Program you'd like to keep!

**Note!** When Nord Electro 2 is shipped from factory, Memory Lock is set to 'On'. To be able to store Programs, first disable the Memory Lock function. See ["Mem Lock" on page 35](#).

To store a Program do like this:

1. Press the **STORE** button once. The Bank and Program number starts flashing in the **DISPLAY**
2. Select Bank (A-F) by pressing the **UP/DOWN NAVIGATOR** buttons (if you want to change Bank) and then Program location by pressing the corresponding **PROGRAM** button (1-8). As you scroll through the memory locations, you can play and hear the Program currently shown in the **DISPLAY**. This prevents you from overwriting a sound that you want to keep. (To cancel the operation, press any button, except for the **SHIFT**, **PROGRAM**, **STORE** or **UP/DOWN** buttons.)
3. Press **STORE** again to store your Program. The **DISPLAY** shows the selected memory location and stops flashing.



## COPYING PROGRAMS

Copying a Program from one memory location to another is just a variation of storing:

1. Select the Program you want to copy. Press the **STORE** button once. The Bank and Program number starts flashing in the **DISPLAY**
1. Select Bank (A-F) by pressing the **UP/DOWN NAVIGATOR** buttons (if you want to change Bank) and then Program location by pressing the corresponding **PROGRAM** button (1-8). As you scroll through the memory locations, you can play and hear the Program currently shown in the **DISPLAY**. This prevents you from overwriting a sound that you want to keep. (To cancel the operation, press any button, except for the **SHIFT**, **PROGRAM**, **STORE** or **UP/DOWN** buttons.)
2. Press **STORE** again to store your Program. The **DISPLAY** shows the selected memory location and stops flashing.



## DELETING PROGRAMS

There is no command for deleting Programs from the internal memory. What you do to “delete” a Program is simply saving a new Program (and thus replacing the old Program) in a specific memory location.

## DOWNLOADING PROGRAMS VIA MIDI

You can receive MIDI Sysex data for one Program at a time into a selected Program location. For example, if you use Nord Electro 2 together with a sequencer, it is often practical to record a Sysex Program data dump in the beginning of your song to download sounds. It’s also possible to receive an entire Program Bank and even all Program Banks as a bulk (see [“Dump” on page 39](#) and [“Receive MIDI Sysex Dumps” on page 44](#)).

# 5. PANEL REFERENCE

## THE ORGAN SECTION

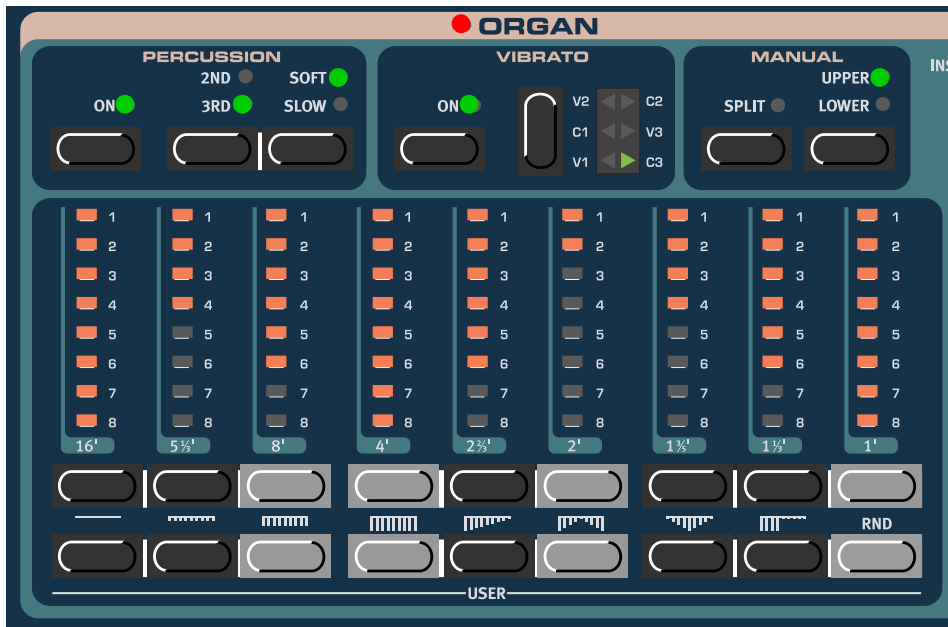

The Organ in the Nord Electro 2 is based on a digital simulation of the mechanical tone wheels of the B-3 organ. It offers innovative solutions to mimic the typical B-3 sound, for example:

- Full polyphony
- An extremely accurate digital model of the original chorus and vibrato scanner
- Modeling of the individual random contact bounces for each partial
- Modeling of the unique frequency characteristics of the built-in pre-amplifier which forms the "body" of the B-3 sound
- Simulation of the energy stealth on the tone wheels that results in the typical "compressed" sound
- Authentic tuning of the tone wheels according to the original B3 design
- Extremely fast keyboard response

The Organ section comprises a number of sub groups which include all the functions found on the original B-3 organ, such as Percussion and Chorus/Vibrato.

## THE DRAWBARS

The drawbars of Nord Electro 2 are represented by buttons and LED chain graphs instead of ordinary mechanical drawbars. This gives you a big advantage: when you change presets or Programs, the correct drawbar settings are recalled immediately and shown by the LEDs. In other words, no need for the regular 'trial and error' method. It's very easy to get the hang of changing the drawbar settings in a natural way with the buttons.

The drawbars of Nord Electro 2 behave similar to their mechanical counterparts, i.e. you "pull out" the drawbars by pressing the **LOWER DRAWBAR** buttons and "push them back in" by pressing the **UPPER DRAWBAR** buttons. The **DRAWBAR** buttons are special in the way that they auto-increment/decrement the drawbar value when held. I.e. if you hold a **DRAWBAR** button the corresponding drawbar value will continue to increment or decrement (within its range) until you release the button. Each drawbar represents a partial. The numbers printed below each **DRAWBAR LED CHAIN** have a history.

Originally, the B-3 was created to mimic a church organ. The numbers on the B-3's drawbars referred to pipe sizes on a church organ. That's why it, for example, says 16', 5 1/3' etc. It corresponds to the church organ's pipe length in foot. In the figure above you can see the pitch interval among the nine drawbars. Note that the second drawbar from the left actually lies 5th *above* the basic partial. However, in most situations it's perceived as sounding *below* the basic partial. When you play different notes on the keyboard, the whole partial "package" is being transposed up or down with the fixed intervals.

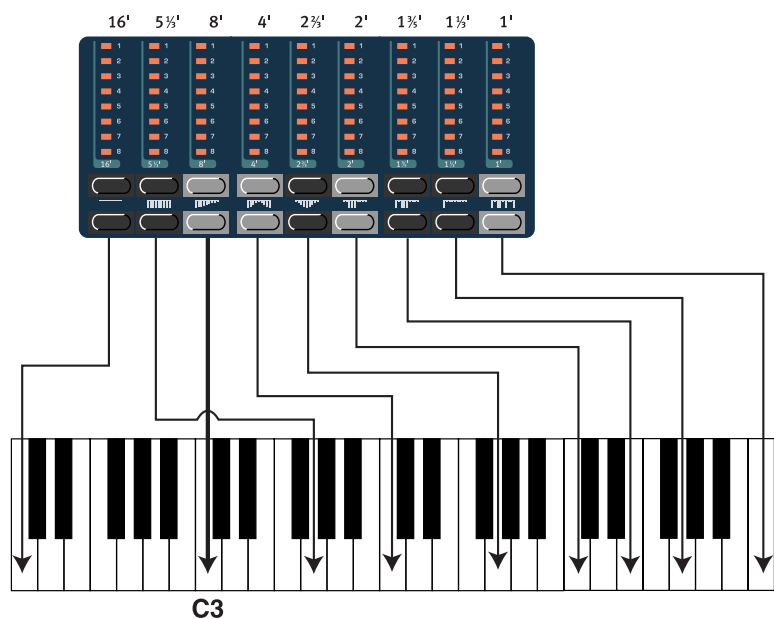

*In the figure above we have chosen C3 as our reference note. The 8' drawbar is considered the basic partial in the organ sound. The arrows point at the respective note that each drawbar represents when C3 is*

## DRAWBAR PRESETS

Below the **UPPER DRAWBAR** buttons are printed 8 drawbar presets plus RND (Random). Press

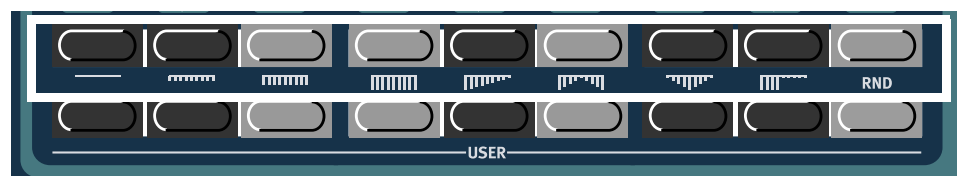

**SHIFT** + the corresponding **UPPER DRAWBAR** button to select one of these presets. There are 8 different drawbar presets plus the 'Random drawbar settings' function. The Random function generates a new random preset every time you activate it.

### USER DRAWBAR PRESETS

There are 9 user configurable drawbar presets in addition to the 9 fixed ones described above.

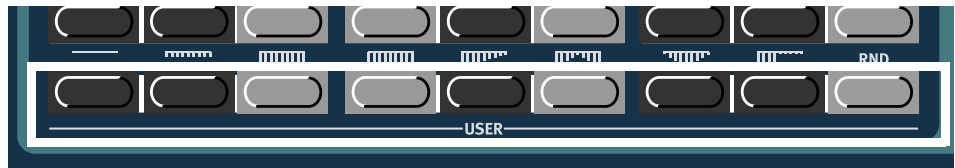

These are located on the **LOWER DRAWBAR** button row. Press **SHIFT** + the corresponding **LOWER DRAWBAR** button to select one of the nine user configurable presets.

### STORE YOUR OWN DRAWBAR PRESETS

To store your own drawbar preset, do like this:

1. Press the **UPPER DRAWBAR** and **LOWER DRAWBAR** buttons to create the drawbar preset you want to store.
2. Press **SHIFT** + **STORE (USER STORE)** + one of the **LOWER DRAWBAR** buttons to select a location for your preset.

### PERCUSSION

In the original B-3 the Percussion effect is generated by a single envelope generator that controls either the 2nd or 3rd partial. The envelope “opens up” for a short moment in the beginning of the sound when you press the key(s). The Percussion effect can be set to control either the 2nd or 3rd partial. The envelope decay time can be set to Fast or Slow and the volume characteristics to Normal or Soft. You activate and deactivate the Percussion effect by pressing the **ON** button.

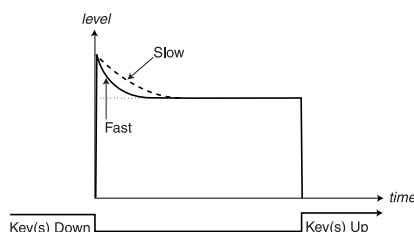
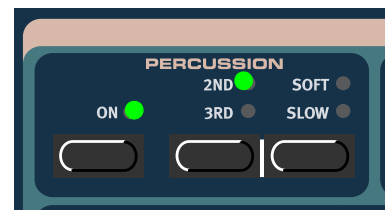

*(The horizontal dotted lines represent the current drawbar level without Percussion)*

*The figure above shows the Percussion envelope in SOFT mode*

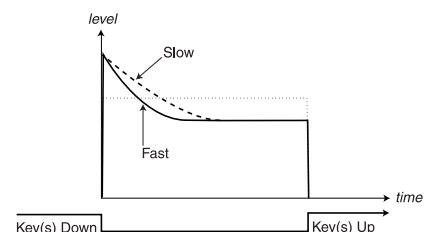

*The figure above shows the Percussion envelope in NORMAL mode*

Like on the original B-3, the Percussion is a single-triggered non-legato effect. By “single-triggered” we mean that the percussion is only present when you hit the keys when no other note is sounding. In other words, if you play a note or a chord and then add on more notes without releasing the previously pressed keys, there will be no percussion effect in the new notes. You have to release all keys to be able to play new notes with the percussion effect. Also, like on the original B-3, in Normal Percussion mode the sustain level is significantly lower than in Soft Percussion mode (or with the Percussion effect disabled).

## VIBRATO

The original B-3 chorus and vibrato scanner consists of a tapped delay line in combination with a rotating scanner. For the Vibrato effect, phase shift is applied to the signal. For the Chorus effect, the phase modulated signal is added to the original signal. A lot of time and effort have been spent in accurately recreating the chorus and vibrato scanner effect. Like on the original, Nord Electro 2 offers three different types of choruses (C1-C3) and three different types of vibratos (V1-V3). Select one of these types by pressing the **SELECTOR** button. You activate and deactivate the Vibrato section by pressing the **ON** button.

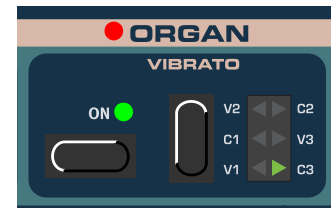

## MANUAL

In the Manual section you can choose to split the Nord Electro 2 keyboard into two sections, the Lower Manual and the Upper Manual. Each Manual can have its own drawbar, percussion and chorus/vibrato settings. If you don't use the Split function you will only have access to the Upper Manual settings from the internal keyboard.

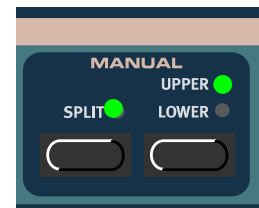

### KEYBOARD SPLIT

Press the **SPLIT** button to divide the Nord Electro 2 keyboard into two sections, the Lower Manual and Upper Manual sections. By default, the split point on the keyboard is between the keys E4 and F4 (Nord Electro 2 61) and between the keys B3 and C4 (Nord Electro 2 73). You can, however, also set the split point manually by holding **SHIFT** + pressing **SPLIT**, the split LED starts to flash, then press the desired key. A manually set split point can be saved with the program.

### UPPER AND LOWER

Press the corresponding button to "highlight" the settings for the respective Manual. Each Manual can have its own drawbar, chorus/vibrato (on/off) and Octave Shift settings. If you don't use the Split function, or use an additional MIDI keyboard (see below), you will only be able to play the Upper Manual from the internal keyboard. Note that the Percussion effect can only be used for the Upper Manual in any situation.

### USING AN ADDITIONAL "LOWER MANUAL" MIDI KEYBOARD

As a special feature of Nord Electro 2 you can connect a second keyboard via MIDI In to use as a Lower Manual keyboard. This way you can play the internal keyboard as the Upper Manual and the additional MIDI keyboard as the Lower Manual. Since the organ has full polyphony you'll have this also when using an additional Lower Manual MIDI keyboard! Do like this to set up the Nord Electro 2 for use with a second keyboard:

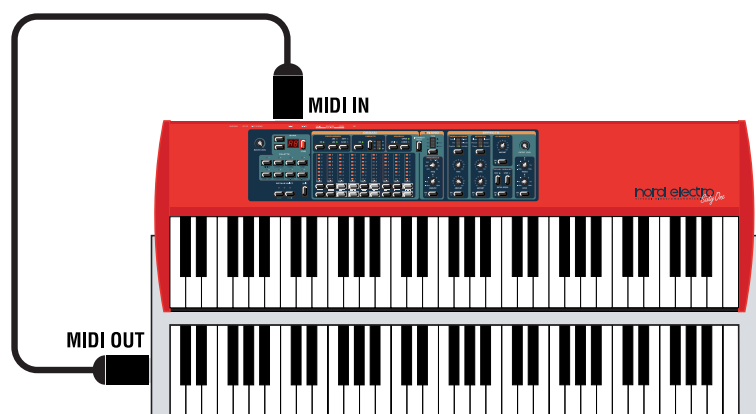

1. Connect the additional MIDI keyboard's MIDI Out to the Nord Electro 2's **MIDI IN**.
2. Select a MIDI channel on the external keyboard.

3. Select the same MIDI channel on the Nord Electro 2 by first pressing **SHIFT + PROGRAM 2 (LOWER CH)** buttons and then scroll with the **UP/DOWN NAVIGATOR** buttons.

**Note:** The MIDI channel set for reception of the additional MIDI keyboard should be different from the “public” MIDI Channel (see “MIDI Ch” on page 34). If the MIDI CH and LOWER CH are the same, playing the additional keyboard would produce a layered sound of the Upper Manual and Lower Manual sounds together. This is normally not what you want.



4. Press any button (except for the **SHIFT**, **STORE** or **UP/DOWN** buttons) to exit.

### SWELL CONTROL (FROM EXPRESSION PEDAL)

Swell is the characteristic B-3 volume function that you control from the B-3’s pedal. Swell is not only a volume control - it also changes the character of the sound in a special way. To use Swell control on the Nord Electro 2, simply plug in a standard resistive expression pedal to the **CONTROL PEDAL** input on the rear panel (see “Connecting pedals” on page 9).

**Note that the expression pedal will only control Swell on Organ sounds - not the volume on Piano sounds. Also, if you use Wah-Wah as modulation effect (see “Wah-Wah 1&2” on page 30), the expression pedal will instead control the Wah-Wah effect and not Swell.**

### ROTARY SPEAKER

The Rotary Speaker simulation in Nord Electro 2 can be found in the Effects section. The reason for this is that you can use it also for Piano sounds. The Rotary Speaker simulation is really something above the ordinary. It’s not only simulating the rotating speaker and drum but also the built-in amplifier of the original Leslie 122 speaker.

Activate or deactivate the Rotary Speaker simulation by pressing the **ON** button. Switch between fast and slow rotor speeds by pressing the **FAST** button. To stop the rotors (but **not** disabling the Rotary Speaker simulation), press the **STOP** button. When you press the **STOP** button again the rotors will accelerate to the speed they had when you first pressed **STOP**.

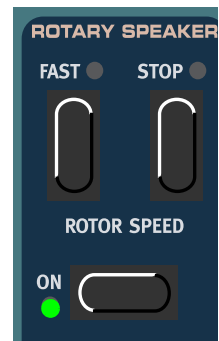

### ROTOR SPEED CONTROL FROM PEDAL

By plugging in a sustain pedal in the **ROTOR SPEED PEDAL** input you can control the speed selection from a pedal. It’s also possible to use a sustain pedal connected to the **SUSTAIN PEDAL** input to control the speed selection. Please refer to “Config” on page 36 for information on how to set up Nord Electro 2 for operation with sustain/switch pedals.

### KEY CLICK CONTROL

On an original B-3 organ, the key click produced by the random contact bounces is actually an artifact. This artifact later became quite desirable an effect amongst musicians. In the Nord Electro 2 you can select the amount of key click that should be present in the organ sounds. The key click level is global for all organ sounds in the Nord Electro 2.

1. Hold down **SHIFT** and press the **PROGRAM 8** button twice. The **DISPLAY** reads 'C.8' where 'C' stands for 'Click' and '8' for the current click level.
2. Select key click level by scrolling with the **UP/DOWN NAVIGATOR** buttons. 'C.0' means minimum key click level and 'C.9' maximum level.
3. Press any button (except for the **SHIFT**, **STORE** or **UP/DOWN** buttons) to exit.



### OUTPUT ROUTING (HARD PAN)

If you want to process your sound using external effects, it can be convenient to route Organ and Piano sounds to separate outputs of the Nord Electro 2. **Note that the Output routing is not saved, so you will have to re-configure after power off.**

1. Hold down **SHIFT** and press the **PROGRAM 8** button three times. The **DISPLAY** reads 'H.0' where 'H' stands for 'Hard pan' and '0' that both Organ and Piano sounds are routed to **LEFT OUT** and **RIGHT OUT** without separation.
2. Select 'separate outputs' by pressing the **UP NAVIGATOR** button so the **DISPLAY** reads 'H.1'. 'H.1' means that Organ sounds will be output only through the **LEFT OUT** and Piano sounds only through the **RIGHT OUT**. **Note that any stereo effect you apply to a sound internally will be in mono in 'H.1' mode.**
3. Press any button (except for the **SHIFT**, **STORE** or **UP/DOWN** buttons) to exit.





## THE PIANO SECTION

The Piano section of Nord Electro 2 comprises a selection of electromechanical pianos. Nord Electro 2 features a unique multi-sample playback, catching every nuance from soft to hard key strokes. Each piano instrument was carefully multi-sampled in a vast amount of velocity levels. That's one of the reasons they all sound and feel so authentic. As an extra bonus we also included an acoustic grand piano (concert model) - in stereo! Nord Electro 2 comes from factory with the following piano instruments:

- Mega Clavinet D6 (Clav) including all the possible filter and pick-up combinations of the original Clavinet D6. 60 + 4 different Clavinet sounds out of a single instrument!
- Wurlitzer 200A (Wur)
- Electric Piano Mk I Stage Piano SeventyThree (E.Piano1). It was built in May 1978 and was adjusted to “deep timbre adjustment”. The so called volume adjustment is set to ‘Low’. These settings gives the piano a warm sound with a rich fundamental
- Clavia Electric Grand Model G (El.Grand). The ‘Model G’ is a custom modified 1934 Gärbstedt acoustic grand piano fitted with CP-80 pick-ups. The Model G produces a very rich and “punchy” rock piano sound that sounds great across the entire note range
- A Malmsjö acoustic grand piano, sampled and played back **in stereo** (Ac.Grand)
- Electric Piano Mk I SeventyThree Suitcase (E.Piano2). It was built in January 1975. We have fine tuned the mechanics and adjusted the tines according to the “ideal timbre adjustment”. The so called volume adjustment is set to ‘Close’. These settings gives the piano a sound with a lot of “bite”



### TYPE

Press the **TYPE** button to select a piano instrument. On the Nord Electro 2 front panel are printed names of the piano instruments loaded from factory. Since all piano samples are stored in Flash memory you can easily add and/or replace the stored piano instruments with new ones (see [“Downloading Piano instruments via USB” on page 40](#)). You can download any piano sound to any of the six locations, i.e. you are not restricted to the configuration printed on the panel. For example, you could have six different Electric Piano sounds (when available) in your Electro 2 at the same time if you like.



**PRESENCE**

The Presence section features a parametric EQ with frequency and amount controls. Use it if you'd like to amplify or attenuate frequency bands of the piano instruments. Activate and deactivate the Presence function by pressing the **ON** button and set the frequency to be amplified or attenuated with the **FREQ** knob. With the **AMOUNT** knob you set the amplification/attenuation in dB.

**Note that the Clavinet D6 instrument that comes with OS V2.X makes use of the Presence effect in a different way (see below).**



**PRESENCE WITH THE MEGA CLAVINET SOUND**

The Mega Clavinet (Clav) sound in the V2.X factory library makes use of the Presence section in a different way than the other piano sounds. On an original Clavinet D6 you can select different pick-up and filter combinations by pressing a number of rocker switches. This functionality is very faithfully simulated in the Nord Electro 2 V2.X. It means that from the Mega Clavinet instrument in the Electro 2 you can get all the 60 different Clavinet D6 sounds plus an additional 4 by selecting different pick-up and filter combinations! This is how it works:

The **FREQ** knob works as a filter selector with which you can select one of the 15 (sounding) combinations of the 'Brilliant', 'Treble', 'Medium' and 'Soft' filters of the original D6. The filter combinations are described in the figure below.

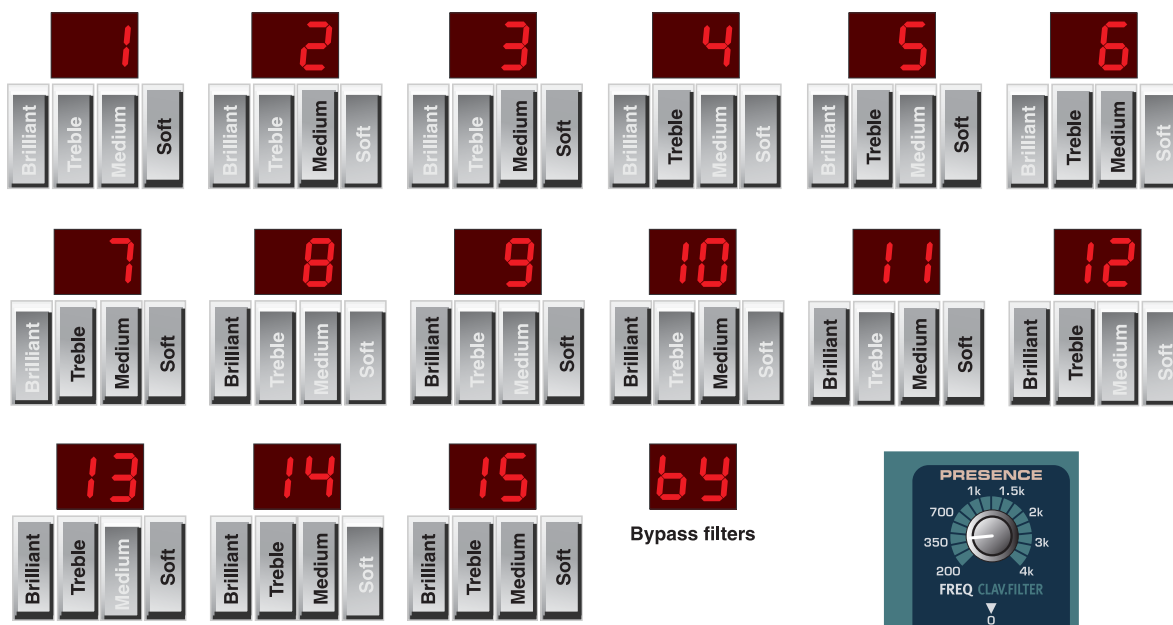

By turning the **FREQ** knob you select one of 15 Clavinet D6 filter combinations plus an additional Bypass variation. The filter combination number is briefly shown in the **DISPLAY** as you turn the **FREQ** knob.

A Clavinet D6 has two separate pick-ups, one on the “neck” and one on the “bridge”. By selecting either one pick-up or both in different combinations you can alter the character of the sound quite drastically. On the Mega Clavinet sound, the **AMOUNT** knob works as the pick-up selector according to the figure below



By turning the **AMOUNT** knob you select one of the four Clavinet D6 pick-up configurations. The pick-up configuration number is briefly shown in the **DISPLAY** as you turn the **AMOUNT** knob.

The configurations are these:

- C.b:** Only the "bridge" pick-up; a bright sound.
- C.A:** Only the "neck" pick-up; a warm, less bright sound.
- d.A:** Both pick-ups on but 180 degrees out of phase; the fundamental is almost cancelled and the sound becomes pretty thin
- d.b:** Both pick-ups on and in phase; a very full sound

### OUTPUT ROUTING (HARD PAN)

If you want to process your sound using external effects, it can be convenient to route Organ and Piano sounds to separate outputs of the Nord Electro 2. **Note that the Output routing is not saved, so you will have to re-configure after power off.**

1. Hold down **SHIFT** and press the **PROGRAM 8** button three times. The **DISPLAY** reads ‘H.0’ where ‘H’ stands for ‘Hard pan’ and ‘0’ that both Organ and Piano sounds are routed to **LEFT OUT** and **RIGHT OUT** without separation.
2. Select ‘separate outputs’ by pressing the **UP NAVIGATOR** button so the **DISPLAY** reads ‘H.1’. ‘H.1’ means that Organ sounds will be output only through the **LEFT OUT** and Piano sounds only through the **RIGHT OUT**. **Note that any stereo effect you apply to a sound internally will be in mono in ‘H.1’ mode.**
3. Press any button (except for the **SHIFT**, **STORE** or **UP/DOWN** buttons) to exit.



### VELOCITY SENSITIVITY FOR THE PIANOS

Some of the piano instruments sampled for the Nord Electro 2 have very wide dynamic ranges by nature and naturally we wanted to capture this as accurately as possible. Therefore, it could be perceived that it is a little hard to reach the most extreme levels when playing the Nord Electro 2 piano sounds with the default keyboard Velocity Sensitivity setting. This is because the dynamic response curves have been very carefully adjusted to match each original instrument's response characteristics. In other words, Clavia's in-

attention was that when you play a Electric Piano sound, for example, it should almost feel like you are playing a Electric Piano. However, If you want the piano sounds to respond more easily to keyboard velocity, you can set this in the Config menu. The Velocity Sensitivity setting is global for all Pianos in the Electro 2.

1. Hold **SHIFT** and press the **PROGRAM 8 (CONFIG)** button four times. The **DISPLAY** reads 'U.0' (Velocity Sensitivity).
2. Change the Velocity Sensitivity between 'U.0' (least sensitive) and 'U.9' (most sensitive) with the **UP/DOWN NAVIGATOR** buttons.
3. Press any button (except for the **SHIFT**, **STORE** or **UP/DOWN** buttons) to exit.



## THE EFFECTS SECTION



The Effects section of Nord Electro 2 can be used for processing both Organ and Piano sounds. It's fully programmable and you can configure your effects separately for each Program. The Effects section consists of five sub groups:

- **Modulations.** Offers six different types of modulations: Ring Modulation, Auto-Panning, Tremolo Wah-Wah 1&2 and Auto-Wah.
- **Effects.** Offers three types of vintage style effects with two variations each: Phaser 1&2, Flanger 1&2 and Chorus 1&2.
- **Overdrive.** Simulates an overdriven tube amplifier.

- Rotary Speaker. Simulates a Leslie rotary speaker including its built-in amplifier
- Treble & Bass EQ. Offers treble and bass amplification/attenuation

In addition to the five sub groups there is also the **OUTPUT LEVEL** control for adjusting the output level of each of the Programs separately.

**MODULATIONS**

The Modulations section offers six different types of modulation. You activate and deactivate the Modulations section by pressing the **ON** button.

**RINGMOD**

Stands for Ring Modulation and is a type of modulation where two signals are multiplied with each other. The result is an inharmonic “bell like” sound. Herbie Hancock used this effect a lot in the ‘70s. In the Nord Electro 2 the Piano or Organ signal is multiplied with an additional sinewave.

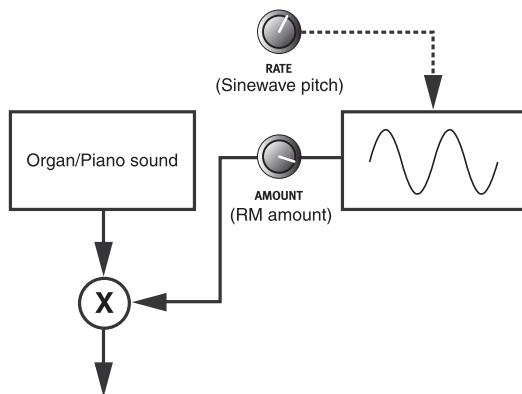

With the **RATE** knob you set the basic pitch of the additional sinewave.

With the **AMOUNT** knob you control the level of ring modulation.



Set the sinewave pitch with the **RATE** knob and the amount of ring modulation with the **AMOUNT** knob.

**PAN**

The Pan is an auto panning modulation that smoothly pans the signal between the Left and Right outputs.

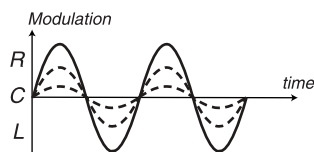

The filled curve indicates maximum **AMOUNT** value and the dashed curves indicate lower **AMOUNT** values. The signal smoothly pans between the **Left** and **Right** outputs as indicated.

You can control the rate and amount of panning with the **RATE** and **AMOUNT** knobs.

**TREMOLO**

Tremolo modulation is basically an automatic volume control that continuously varies the output signal volume. Tremolo is a commonly used modulation, especially on the Wurlitzer electric pianos.

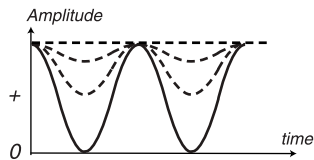

*The filled curve indicates maximum **AMOUNT** value and the dashed curves indicate lower **AMOUNT** values. At zero **AMOUNT** value the output level is constantly at maximum level*

Use the **RATE** and **AMOUNT** knobs to control the Tremolo rate and depth. Note that the output volume is at maximum level at zero **AMOUNT** setting.

**WAH-WAH 1 & 2**

The Wah-Wah modulation is often used for electric guitars to get that characteristic “talking guitar” sound. Wah-Wah can also be extremely useful on electric piano sounds. Try out the Clavinet sound with Wah-Wah modulation and you’ll understand. Basically, the Wah-Wah modulation is a lowpass type of filter that can be swept across the frequency range. During the sweep, the filter’s characteristics also changes.

For the Wah-Wah1 modulation you control the “pedal position” with the **RATE** knob and the total frequency sweep range with the **AMOUNT** knob. For the Wah-Wah2 modulation you control the LFO rate with the **RATE** knob and the total frequency sweep range with the **AMOUNT** knob.

**Note:** If you use an expression pedal connected to the CONTROL PEDAL INPUT you can control the filter sweep and thus the Wah-Wah1 effect from the pedal. Also note that if you’re already using an expression pedal for Organ Swell control (see “Swell control (from expression pedal)” on page 23), the Wah-Wah function takes precedence and automatically disables the Swell control.

**AUTO-WAH**

Auto-Wah is a variation of the Wah-Wah modulation described above. The difference is that here you control the filter sweep range, and thus the Wah-Wah effect, from the signal’s amplitude envelope. For the Auto-Wah modulation you control the attack time with the **RATE** knob and the sensitivity with the **AMOUNT** knob.

## EFFECTS

Nord Electro 2 offers six types of vintage style effects to add that extra flavour to your sounds. Activate or deactivate the Effects section by pressing the **ON** button.

### PHASER 1 & 2

The phaser effect is a very characteristic “sweep” effect and is frequently used in all sorts of music. You control the rate of the phase shift with the **RATE** knob and the phase shift amount with the **AMOUNT** knob.

### FLANGER 1 & 2

The flanger effect is another type of very characteristic “sweep” effect. It’s quite similar to the phaser effect but has a little different characteristics. You set the flanging rate with the **RATE** knob and the amount with the **AMOUNT** knob.

### CHORUS 1 & 2

The Chorus effect simulates the appearance of several slightly detuned signals. You set the rate for the chorus effect with the **RATE** knob and the amount with the **AMOUNT** knob. Note that the Chorus2 effect is in stereo.



## OVERDRIVE

The Overdrive effect is a simulation of an overdriven tube amplifier. It’s very useful both on Organ and Piano sounds. Activate or deactivate the Overdrive effect with the **ON** button and set the overdrive amount with the **AMOUNT** knob.



## ROTARY SPEAKER

The Rotary Speaker simulation in Nord Electro 2 is really something above the ordinary. It’s not only simulating the rotating speaker and drum but also the built-in amplifier of the original Leslie speaker.

Activate or deactivate the Rotary Speaker simulation by pressing the **ON** button. Switch between fast and slow rotor speeds by pressing the **FAST** button. To stop the rotors, press the **STOP** button (this does **not** deactivate the Rotary Speaker simulation - it only stops the rotors). When you press the **STOP** button again the rotors will accelerate to the speed they had when you first pressed **STOP**.

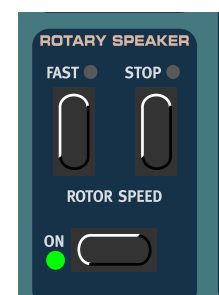

### ROTOR SPEED CONTROL FROM PEDAL

By plugging in a sustain pedal in the **ROTOR SPEED PEDAL** input you can control the speed selection from a pedal. It’s also possible to use a sustain pedal connected to the **SUSTAIN PEDAL** input to control the speed selection. Please refer to “[Config](#)” on page 36 for information on how to set up Nord Electro 2 for operation with sustain/switch pedals.

## OUTPUT LEVEL

The **OUTPUT LEVEL** knob controls the individual output volume for each Program. It's fully programmable for each Program and sends/receives MIDI CC# 7 (Main Volume).

**Note: The Output Level is always active even if no other sub groups of the Effects section are active.**



## TREBLE & BASS

The last group of the effects section is a 2-band equalizer which features controls for bass and treble. Activate or deactivate the equalizer by pressing the **ON** button. Adjust the treble and bass with the corresponding **KNOBS**. The bass and treble settings are fully programmable for each Program.



## THE LEFT PANEL SECTION

The left panel section features controls for Program handling, system functions, MIDI functions etc. There, you'll also find the Octave Shift and Transpose functions.

### MASTER LEVEL

The **MASTER LEVEL** knob controls the output level from the two **OUT** jacks and the **HEADPHONES** output. **The MASTER LEVEL knob does not send or receive any MIDI CC# but is used to control the entire instrument's output level.** (For info on how to control the level(s) of the individual sounds and via MIDI, please refer to "Output Level" on page 32).

### NAVIGATOR BUTTONS

The **UP** and **DOWN NAVIGATOR** buttons are used for selecting Program Banks (A-F) and also for selecting system related functions (see "System functions" on page 33).

### DISPLAY

The **DISPLAY** is mainly used for displaying Program Banks and Program numbers. It also displays system related functions described in the 'System functions' paragraph below.





### STORE

The red **STORE** button is used for storing Programs and Drawbar presets and also for executing various system related operations.

### PROGRAM BUTTONS

The **PROGRAM** buttons 1-8 are used for selecting Programs from the internal memory and also for accessing the different system functions described below.

### OCTAVE SHIFT

The two **OCTAVE SHIFT** buttons to the bottom left on the front panel can be used to transpose the notes two octaves up or down (if the selected instrument supports this). A flashing **OCTAVE SHIFT LED** indicates +/ - 2 octaves note shift.



**Note: Due to the actual key range of the original Piano instruments, some sounds cannot be octave shifted up and/or down. For organ sounds, the Octave Shift will only generate notes that are within the 73-key note range of Nord Electro 2 73. This means that using Octave Shift for Organ sounds in Nord Electro 2 73 won't produce any sound in the lowest or highest octave.**

### THE SHIFT BUTTON

To the right of the **OCTAVE SHIFT** buttons is the **SHIFT** button. It's used to access various kinds of system functions etc.



### SYSTEM FUNCTIONS

To access the system functions, press and hold **SHIFT** and press the corresponding **PROGRAM** button. **All changes you make in the system parameters are automatically stored in Nord Electro 2, with some exceptions: 'MIDI Local Off', 'Master Tune', 'Transpose' and 'Output routing (Hard pan)' are not stored.**

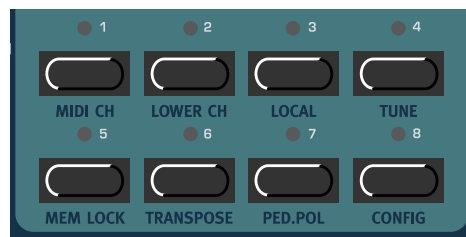

## MIDI CH

Press the **SHIFT + PROGRAM 1 (MIDI CH)** buttons to enter the MIDI Channel function. Here you set the MIDI Channel for the Nord Electro 2 to send and respond to. Select MIDI Channel with the **UP/DOWN NAVIGATOR** buttons. Press any button (except for the **SHIFT, STORE** or **UP/DOWN** buttons) to exit.  
Range: 1-16, -- (off)

**Note: If the MIDI CH and LOWER CH (see below) are set to the same number, incoming MIDI notes will produce a layered sound of the Upper Manual and Lower Manual sounds together. This is normally not what you want, so keep the channels separated from each other.**



## LOWER CH

Press the **SHIFT + PROGRAM 2 (LOWER CH)** buttons to enter the Lower MIDI Channel function. Here you set the MIDI channel for the Lower Manual of Nord Electro 2 Organ section to respond to. Select Lower MIDI Channel with the **UP/DOWN NAVIGATOR** buttons. Press any button (except for the **SHIFT, STORE** or **UP/DOWN** buttons) to exit. See [“Using an additional “Lower Manual” MIDI keyboard” on page 22](#) for more details on how to use an external “Lower Manual” MIDI keyboard.  
Range: 1-16, -- (off)

**Note: If the LOWER CH and MIDI CH (see above) are set to the same number, incoming MIDI notes will produce a layered sound of the Upper Manual and Lower Manual sounds together. This is normally not what you want, so keep the channels separated from each other.**



## LOCAL

Press the **SHIFT + PROGRAM 3 (LOCAL)** buttons to enter the MIDI Local on/off function. Here you set whether the Nord Electro 2 keyboard and front panel controls should control internal Programs or only send MIDI. Local On is the normal “play mode”. In Local Off mode, the front panel and keyboard actions are transmitted via MIDI only and does not control the internal sound(s) at all. (The MIDI In works as usual, though.)

Local Off should be used when you use a sequencer to record and play back from Nord Electro 2. When using a sequencer, you connect the MIDI Out of Nord Electro 2 to the sequencer’s MIDI In. Then, from the sequencer’s MIDI Out back to



the Nord Electro 2's MIDI In. Since the sequencer echoes back incoming MIDI data, Nord Electro 2 will respond normally to your playing and knob tweaking via the MIDI "loop". If you use Local On in the sequencer setup described above, you will get double-notes when you play: from the keyboard internally and via the MIDI "loop". This is not what you want. Therefore, always use Local Off together with sequencers.

Select Local On or Local Off with the **UP/DOWN NAVIGATOR** buttons. Press any button (except for the **SHIFT, STORE** or **UP/DOWN** buttons) to exit. **Note that 'Local Off' is not saved, so you will have to reconfigure after power off.**

## TUNE

The Master Tune function is global for all sounds in Nord Electro 2, i.e. changing it will affect all Programs. Press the **SHIFT + PROGRAM 4 (TUNE)** buttons to enter the Master Tune function.

1. Change the master tune, in cents, with the **UP/DOWN NAVIGATOR** buttons. '0' is normal 440Hz tuning. The range is +/- 1 semitone in steps of 1 cent (hundreds of a semitone).
2. Press any button (except for the **SHIFT, STORE** or **UP/DOWN** buttons) to exit.



## MEM LOCK

Press the **SHIFT + PROGRAM 5 (MEM LOCK)** buttons to enter the Memory Lock function. Here you can choose to memory protect all Programs of the internal memory. Select Memory Protect 'On' or 'OF' with the **UP/DOWN NAVIGATOR** buttons. Press any button (except for the **SHIFT, STORE** or **UP/DOWN** buttons) to exit.

**Note! When Nord Electro 2 is shipped from factory, Memory Lock is set to 'On'. To be able to store Programs (and receive MIDI Sysex dumps), set Memory Lock to 'OF'.**



## TRANSCOPE

The Transpose function is global for all sounds in Nord Electro 2, i.e. changing it will affect all Programs. Press **SHIFT + PROGRAM 6 (TRANSCOPE)** buttons. The **DISPLAY** reads '0'. Press the **UP/DOWN NAVIGATOR** buttons to transpose the sounds up or down in semitone steps. The range is +/- 6 semitones in steps of 1 semitone. Press any button (except for the **SHIFT, STORE** or **UP/DOWN** buttons) to exit. **Note that the Transpose setting is not saved, so you will have to reconfigure after power off.**

**Note: Due to the actual key range of the original Piano instruments, the lowest keys may not produce any sound when the instrument is transposed down. The same goes for the highest keys when the instrument is transposed up. For organ sounds, the Transpose function will only generate notes that are within the 73-key note range of Nord Electro 2 73, i.e. F1-F7. This means that using the Transpose function for Organ sounds in Nord Electro 2 73 will cause the lowest or highest notes of the keyboard to be silent.**



## PED. POL

Press the **SHIFT + PROGRAM 7 (PED.POL)** buttons to set up the Sustain Pedal and Rotor Speed Pedal polarity. Change pedal polarity between 'OP' (Open) (open when pressed) and 'CL' (Closed) (closed when pressed) with the **UP/DOWN NAVIGATOR** buttons. Press any button (except for the **SHIFT, STORE** or **UP/DOWN** buttons) to exit.

Nord Electro 2 sends and receives Sustain Pedal messages as MIDI CC# 64 and Rotor Speed Pedal messages as MIDI CC#82.



## CONFIG

Press the **SHIFT + PROGRAM 8 (CONFIG)** buttons once to enter the Pedal Configuration function. Here you select how you want to configure the **SUSTAIN PEDAL** input. There are two options:

1. If you're using a single sustain pedal in the **SUSTAIN PEDAL** input you may want to use it for sustain with Piano sounds and as a Rotor Speed switch with Organ sounds. In this case, select 'P.t' (Pedal toggle) with the **UP/DOWN NAVIGATOR** buttons. Press any button (except for the **SHIFT, STORE** or **UP/DOWN** buttons) to exit.



- If you're using two separate sustain pedals: one in the Sustain Pedal Input and one in the Rotor Speed Input you probably want to use the sustain pedal in the **SUSTAIN PEDAL** input for sustain also with Organ sounds. In this case, select 'P.S' (**Pedal Sustain**) with the **UP/DOWN NAVIGATOR** buttons. Exit by pressing any button (except for the **SHIFT** button).

**Note: It's possible to use this configuration also if you're only using a single sustain pedal in the Sustain Pedal input. In that case you'll have to control the Rotor Speed from the front panel.**

Nord Electro 2 sends and receives Sustain Pedal messages as MIDI (CC# 64). **Note! If you have selected 'P.t', Rotor Speed selection is sent from the sustain pedal as MIDI CC#82 - not CC#64!**

### KEY CLICK CONTROL

On an original B-3 organ, the key click produced by the random contact bounces is actually an artifact. This artifact later became quite desirable an effect amongst musicians. In the Nord Electro 2 you can select the amount of key click that should be present in the organ sounds. The key click level is global for all organ sounds in the Nord Electro 2.

- Hold down **SHIFT** and press the **PROGRAM 8** button twice. The **DISPLAY** reads 'C.8' where 'C' stands for 'Click' and '8' for the current click level.
- Select key click level by scrolling with the **UP/DOWN NAVIGATOR** buttons. 'C.0' means minimum key click level and 'C.9' maximum level.
- Press any button (except for the **SHIFT**, **STORE** or **UP/DOWN** buttons) to exit.



### OUTPUT ROUTING (HARD PAN)

If you want to process your sound using external effects, it can be convenient to route Organ and Piano sounds to separate outputs of the Nord Electro 2. **Note that the Output routing is not saved, so you will have to reconfigure after power off.**

- Hold down **SHIFT** and press the **PROGRAM 8** button three times. The **DISPLAY** reads 'H.0' where 'H' stands for 'Hard pan' and '0' that both Organ and Piano sounds are routed to **LEFT OUT** and **RIGHT OUT** without separation.
- Select 'separate outputs' by pressing the **UP NAVIGATOR** button so the **DISPLAY** reads 'H.1'. 'H.1' means that Organ sounds will be output only through the **LEFT OUT** and Piano sounds only through the **RIGHT OUT**. **Note that any stereo effect you apply to a sound internally will be in mono in 'H.1' mode.**



3. Press any button (except for the **SHIFT**, **STORE** or **UP/DOWN** buttons) to exit.

### VELOCITY SENSITIVITY FOR THE PIANOS

Some of the piano instruments sampled for the Nord Electro 2 have very wide dynamic ranges by nature and naturally we wanted to capture this as accurately as possible. Therefore, it could be perceived that it is a little hard to reach the most extreme levels when playing the Nord Electro 2 piano sounds with the default keyboard Velocity Sensitivity setting. This is because the dynamic response curves have been very carefully adjusted to match each original instrument's response characteristics. In other words, Clavia's intention was that when you play a Electric Piano sound, for example, it should almost feel like you are playing a Electric Piano. However, If you want the piano sounds to respond more easily to keyboard velocity, you can set this in the Config menu. The Velocity Sensitivity setting is global for all Pianos in the Electro 2.

1. Hold **SHIFT** and press the **PROGRAM 8 (CONFIG)** button four times. The **DISPLAY** reads 'U.0' (Velocity Sensitivity).
2. Change the Velocity Sensitivity between 'U.0' (least sensitive) and 'U.9' (most sensitive) with the **UP/DOWN NAVIGATOR** buttons.
3. Press any button (except for the **SHIFT**, **STORE** or **UP/DOWN** buttons) to exit.



### LESLIE ACCELERATION RATE

You have the option to choose between three Leslie acceleration up and down rates.

1. Hold **SHIFT** and press the **PROGRAM 8 (CONFIG)** button five times. The **DISPLAY** reads 'L.1' (Leslie).
2. Change the acceleration rate between 'L.0' (slowest) and 'L.2' (fastest) with the **UP/DOWN NAVIGATOR** buttons.
3. Press any button (except for the **SHIFT**, **STORE** or **UP/DOWN** buttons) to exit.



## DUMP

Press the **SHIFT + LEFT OCTAVE SHIFT (DUMP)** buttons to enter the Dump menu. Here you can perform a MIDI Sysex dump of the currently selected Program or of all Programs of the internal memory. You can also perform a dump of all MIDI Controllers for the selected Program. Select the type of dump to perform by pressing the **UP/DOWN NAVIGATOR** buttons. 'Pr' in the **DISPLAY** means a single Program dump, 'AL' means **All Programs** dump and 'Ct' means dump all MIDI Controllers of the currently selected Program. The selected dump type will flash in the **DISPLAY**. If you want to perform a MIDI Sysex dump of a single Program or of the MIDI Controllers of a Program, select it by choosing Program Bank with the **UP/DOWN NAVIGATOR** buttons and Program by pressing the corresponding **PROGRAM** button. If you're about to send all Programs ('AL') it doesn't matter which Program is selected. Press the **STORE** button to send the dump to the **MIDI OUT** of Nord Electro 2. The Display will stop flashing once the dump has been sent.



**Note: For Organ Sysex, the complete settings for the sound will be dumped as MIDI Sysex. For Piano sounds, all parameters will be sent but NOT the actual instrument samples. Therefore, when dumping back a Piano sound, make sure the actual instrument samples are already loaded in the Nord Electro 2. Otherwise the parameters in the Sysex message will be applied to another available Piano instrument.**

### A WORD ABOUT MIDI CONTROLLER DUMP

Consider a situation where you record a Controller message, e.g. a Drawbar opening, in the middle of your sequencer song. Then you "rewind" the sequencer to a position before the recorded Drawbar opening. The problem is that the Nord Electro 2's Drawbar will remain opened, although it really should be as it was before you recorded the opening. To solve such problems, several sequencers include a function called "Controller Chasing", which keeps track of Controller changes and tries to adjust the settings on the instrument according to the current position in the sequencer song.

However, in our example this wouldn't help much, because the Drawbar opening was the first Controller message recorded in the song. The sequencer has no information about the Drawbar setting before the recorded change, and therefore cannot "chase" the settings properly. To solve this, you could record a "snapshot" of all Controller settings of the Nord Electro 2 Program(s) at the beginning of your sequencer song. In these situations you can use the 'dump all MIDI Controllers' function.

## PANIC

If notes should hang or the Electro 2 should behave strange in a MIDI set-up, for example, all you need to do is hold down the **SHIFT** button and press the **RIGHT OCTAVE SHIFT (PANIC)** buttons. This will execute an internal All Notes Off, and reset certain parameters to their default values.



# 6. FACTORY PRESETS AND OS

## INTERNAL MEMORY

The Operating System, Programs and Piano samples in Nord Electro 2 are stored in a so-called Flash memory. A Flash memory keeps the data also when the power is shut off. Another big advantage is that you can replace data in the Flash memory at any time. This means that you will be able to download OS upgrades and Programs to your Nord Electro 2 from a computer or sequencer without needing to replace or add any new hardware. Nord Electro 2 also features a USB port for quick and easy download of new Piano instrument samples.

The internal sound memory of Nord Electro 2 consists of 6 Banks (A-F) holding 8 Programs each for a total of 48 Programs.

## FACTORY PRESETS

All factory Programs of Nord Electro 2 can be replaced. To make sure you don't accidentally overwrite Programs you want to keep, it's a good idea to back up your sounds regularly on a computer or on a hardware sequencer that can record and play back MIDI Sysex. data. For information on how to back up Programs please refer to ["Dump" on page 39](#).

### RESTORING THE FACTORY PRESETS

The factory Programs will be available as a MIDI Sysex file for download at the Clavia web site at <http://www.clavia.se>. Please refer to ["Receive MIDI Sysex Dumps" on page 44](#) for information on how to restore the factory presets.

## DOWNLOADING PIANO INSTRUMENTS VIA USB

This function is supported in the V2.X Nord Electro 2 operating system when you use the special Electro Tool USB dump application. With the Electro Tool you will be able to download and add/replace/erase piano sounds in the Flash memory of the Nord Electro 2. Please visit <http://www.clavia.se/nordelectro/software.htm> to download the Electro Tool USB dump application for Mac (OS X/OS 9) and PC (Windows) - free of charge!

## OS UPGRADES

The latest OS version for Nord Electro 2 will be available for download at <http://www.clavia.se>.



# 7. MIDI FUNCTIONS

## ABOUT THE MIDI IMPLEMENTATION

The following MIDI messages can be transmitted and received from Nord Electro 2:

### NOTE ON/OFF

- Note On and Note Off messages are of course transmitted when you play the keyboard. If you use the **OCTAVE SHIFT** function (see “[Octave Shift](#)” on page 33), you can transpose the Nord Electro 2 keyboard  $\pm 2$  octaves (if the selected instrument supports this).
- Notes can be received over the entire MIDI Note range. However, due to the actual note range of the controlled instrument type, there will be silent notes when exceeding their ranges.

### PITCH BEND

- Pitch Bend messages are neither transmitted nor recognized by the Nord Electro 2.

### CONTROLLERS

- If you have an Control/Expression pedal connected to the **CONTROL PEDAL INPUT**, this is transmitted and received as Controller 11 (Expression).
- If you have a sustain pedal connected to the **SUSTAIN PEDAL INPUT**, this is transmitted and received as Controller 64 (Sustain Pedal).
- If you have a sustain pedal connected to the **ROTOR SPEED INPUT**, this is transmitted and received as Controller 82.
- All other controls (knobs and buttons) on the front panel (except **MASTER LEVEL**), are also transmitted and received as Control Change messages. This can be used to record your actions on the front panel into a MIDI sequencer. For a full list of which parameters correspond to which Controller number, see the MIDI implementation chapter on [page 45](#).

### KEYBOARD VELOCITY

Nord Electro 2 can transmit and receive Keyboard Velocity messages. **Note that incoming Keyboard Velocity data is ignored when in Organ mode. Organ sounds will always be played back at nominal level regardless of incoming MIDI Velocity data.**

### PROGRAM CHANGE

When you select a Program, a Program Change message is transmitted via MIDI on the selected MIDI Channel. If a Program Change message is received on the selected MIDI Channel, Nord Electro 2 will change Program accordingly. The 48 Program locations send and respond to Program Change values 0-47 where 0 is Program A1 and 47 is Program F8.

## MIDI SYSEX (SYSTEM EXCLUSIVE)

Single Programs or all Programs can be transmitted and received as a System Exclusive dump (see “[Dump](#)” on page 39.).

# USING NORD ELECTRO 2 WITH A SEQUENCER

## CONNECTIONS

1. Connect the MIDI Out on the Nord Electro 2 to the MIDI In on your sequencer.
2. Connect the MIDI Out from your sequencer to the MIDI In on the Nord Electro 2.

## LOCAL ON/OFF

If your sequencer “echoes” all received MIDI signals via its MIDI output(s), the Nord Electro 2 should be set to Local Off. This is important because otherwise you will get “double-notes”; from the internal keyboard and via the MIDI loop. See “[Local](#)” on page 34.

## MIDI CHANNEL

1. Set up Nord Electro 2 so that it transmits/receives on the desired MIDI channel. See “[MIDI Ch](#)” on page 34 for details on how to set up the MIDI channel.
2. Select the desired Program.
3. If needed, set the sequencer up to record and play back on the desired MIDI Channel.
4. Activate recording and play the Nord Electro 2.

## PROGRAM CHANGE

To record a Program Change message, activate recording in the sequencer and simply select a new Bank (A-F) and Program (1-8) by using the **UP/DOWN NAVIGATOR** buttons and the **PROGRAM** buttons. The 48 Program locations send and respond to Program Change values 0-47 where 0 is Program A1 and 47 is Program F8.

## CONTROLLERS

When you record knob movements and button presses, make sure that the sequencer “echoes” the changes back on the correct MIDI Channel, or your changes won’t have any effect.

## SOME NOTES ABOUT CONTROLLERS AND “CHASING”

Consider a situation where you record a Controller message, e.g. a Drawbar opening, in the middle of your sequencer song. Then you “rewind” the sequencer to a position before the recorded Drawbar opening. The problem is that the Nord Electro 2’s Drawbar will remain opened, although it really should be as it was before you recorded the opening. To solve such problems, several sequencers include a function called “Controller Chasing”, which keeps track of Controller changes and tries to adjust the settings on the instrument according to the current position in the sequencer song.

However, in our example this wouldn't help much, because the Drawbar opening was the first Controller message recorded in the song. The sequencer has no information about the Drawbar setting before the recorded change, and therefore cannot "chase" the settings properly. To solve this, you could record a "snapshot" of all Controller settings of the Nord Electro 2 Program(s) at the beginning of your sequencer song. This can be done by using the 'MIDI Controllers Dump' function described below.

## PROGRAM AND CONTROLLER DUMPS

To dump Program Sysex or MIDI Controllers via MIDI, to another Nord Electro 2 or for recording the data into another MIDI device, do like this:

1. Connect a cable from **MIDI OUT** on the Nord Electro 2 to MIDI In on the receiving device.
2. Set up the receiving device so that it accepts MIDI Sysex and MIDI Controller data.
3. Press the **SHIFT + LEFT OCTAVE SHIFT** buttons to enter the Dump menu. Select what to dump by pressing the **UP/DOWN NAVIGATOR** buttons. 'Pr' flashing in the **DISPLAY** means 'single Program Dump', 'Al' means 'All Programs Dump' and 'Ct' means 'MIDI Controllers Dump'. If you're about to dump a single Program or MIDI Controllers for a Program, select the Program by choosing Program Bank with the **UP/DOWN NAVIGATOR** buttons and Program by pressing the corresponding **PROGRAM** button.
4. If needed, set the receiving MIDI device to "recording mode".
5. Press the **STORE** button to send the dump to the **MIDI OUT** of Nord Electro 2. The Display will stop flashing once the dump has been sent.



**Note:** For Sysex dumps of Organ sounds, the complete settings for the sound will be dumped as MIDI Sysex. For Piano sounds, all parameters will be sent but NOT the actual instrument samples. Therefore, when dumping back a Piano Sysex, make sure the actual instrument sound is already loaded in the Nord Electro 2. Otherwise the parameters in the Sysex message will be applied to another available Piano instrument. However, the Nord Electro 2 works in an intelligent way regarding substituting Piano sounds. Let's say you dumped a Program Sysex based on the E.Piano1 sound and then erased the E.Piano1 sound. When you load the Program Sysex back to the Electro 2, it will apply another available Electric Piano sound, the E.Piano2 or E.Piano3, for example. If no Electric Piano sound is available, another piano sound will be applied.

## RECEIVE MIDI SYSEX DUMPS

To receive a MIDI Sysex Dump, do like this:

1. Connect a cable from the MIDI Out on the transmitting device to **MIDI IN** on the Nord Electro 2.
2. Initiate the transmission on the transmitting device.

If the dump contained all Programs (AL), it will replace all Programs currently stored in the Nord Electro 2. If the dump contained only a single Program (Pr), it will be temporarily placed in the currently selected Program memory location. You will then have to store the Program manually to a memory location using the Store function (see [“Storing a Program”](#) on page 17).

**Note: For Organ sounds, the complete settings for the sound will be received with the MIDI Sysex file. For Piano sounds, all parameters will be received but not the actual instrument samples. Therefore, when receiving a Piano MIDI Sysex file, make sure the instrument samples are already present in the Nord Electro 2. Otherwise the parameters of the Sysex file will be applied to another available Piano instrument.**

# 8. MIDI IMPLEMENTATION

## MIDI CONTROLLER LIST

The following is a list of the MIDI Controller numbers used for all **KNOBS** and **BUTTONS** on the front panel. All parameters use the entire control range 0-127. For **BUTTONS** and for some other parameters the range is divided into equally big “sections” depending on the number of states of the parameter. For example, the **MODULATIONS** selector can have 6 different “positions” and are therefore divided into 6 equally large sections between the values 0 and 127.

Nord Electro 2 Parameter	MIDI Controller #	MIDI Controller Name
<b>“Play Control” parameters:</b>		
Octave Shift Upper Manual (Organ)	27	
Octave Shift Lower Manual (Organ)	28	
Octave Shift (Piano)	29	
<b>Organ section parameters:</b>		
16' Upper Drawbar	16	
5 1/3' Upper Drawbar	17	
8' Upper Drawbar	18	
4' Upper Drawbar	19	
2 2/3' Upper Drawbar	20	
2' Upper Drawbar	21	
1 3/5' Upper Drawbar	22	
1 1/3' Upper Drawbar	23	
1' Upper Drawbar	24	
16' Lower Drawbar	70	
5 1/3' Lower Drawbar	71	
8' Lower Drawbar	72	
4' Lower Drawbar	73	
2 2/3' Lower Drawbar	74	
2' Lower Drawbar	75	
1 3/5' Lower Drawbar	76	
1 1/3' Lower Drawbar	77	
1' Lower Drawbar	78	

<b>Nord Electro 2 Parameter</b>	<b>MIDI Controller #</b>	<b>MIDI Controller Name</b>
Percussion Upper On/Off	87	
Percussion Upper Fast/Slow, Normal/Soft	88	
Percussion Upper 2nd/3rd	95	
Vibrato Upper On/Off	85	
Vibrato Lower On/Off	86	
Vibrato Type	84	
Manual Split On/Off	25	
Manual Lower/Upper	26	
<b>Instrument Select Organ/Piano</b>	13	
<b>Piano section parameters:</b>		
Piano Type*	12	
Piano Sub Type*	44	
Presence On/Off	102	
Presence Frequency	30	
Presence Amount	31	
<b>Effects section parameters:</b>		
Modulations Type	103	
Modulations Rate	104	
Modulations Amount	105	
Modulations On/Off for the Organ	106	
Modulations On/Off for the Piano	91	
Effects Type	107	
Effects Rate	108	
Effects Amount	109	
Effects On/Off for the Organ	110	
Effects On/Off for the Piano	92	
Overdrive On/Off for the Organ	112	
Overdrive On/Off for the Piano	93	
Overdrive Amount	111	
Rotary Speaker On/Off for the Organ	81	
Rotary Speaker On/Off for the Piano	94	

<b>Nord Electro 2 Parameter</b>	<b>MIDI Controller #</b>	<b>MIDI Controller Name</b>
Rotary Speaker Fast/Slow	82	
Rotary Speaker Run/Stop	83	
Output Level	7	Main Volume
Treble & Bass EQ On/Off for the Organ	115	
Treble & Bass EQ On/Off for the Piano	96	
Treble	113	
Bass	114	
<b>Future Expansion parameters</b>		
Future Expansion #1	116	
Future Expansion #2	117	
Future Expansion #3	118	
Future Expansion #4	119	
Future Expansion #5	89	
Future Expansion #6	90	

\* The parameters 'Piano Type' and 'Piano Sub Type' are used to define the exact type of Piano instrument used and not its position in the **TYPE** selector.

In addition to the above, following MIDI Controllers are used:

- If an expression pedal is used in the **CONTROL PEDAL INPUT**, it's transmitted as Controller 11.
- If a sustain pedal is used in the **SUSTAIN PEDAL INPUT** (and configured to be used for 'Sustain'), it's transmitted as Controller 64 (Damper Pedal)
- If a sustain pedal is used in the **ROTOR SPEED INPUT**, or in the **SUSTAIN PEDAL INPUT** (and configured to be used for 'Rotor Speed'), it's transmitted as Controller 82.

**MIDI IMPLEMENTATION CHART**

Model: Clavia Nord Electro 2 OS V2.0x

Date: 2002-06-11

Function		Transmitted	Recognized	Remarks
Basic Channel	Default Channel	1 – 16 1 – 16	1 – 16 1 – 16	
Mode	Default Messages Altered	Mode 3 X *****	Mode 3 X	
Note Number	True Voice	29 – 101 *****	29 – 101 29 – 101	
Velocity	Note ON Note OFF	O v = 1 – 127 O	O v = 1 – 127 O	Incoming Velocity data ignored in Organ mode.
Aftertouch	Key Channel	X X	X X	
Pitch Bend		X	X	
Control Change		O	O	See "MIDI Controller list" on page 45.
Program Change	True #	O 0 – 47	O 0 – 47	
System Exclusive		O	O	See the MIDI Implementation section.
System Common	: Song Pos : Song Sel : Tune	X X X	X X X	
System Real Time	: Clock : Commands	X X	X X	
Aux Messages	: Local ON/OFF : All Notes Off : Active Sense : Reset	X X X X	X X X X	
Notes				

Mode 1: OMNI ON, POLY  
Mode 3: OMNI OFF, POLY

Mode 2: OMNI ON, MONO  
Mode 4: OMNI OFF, MONO

O: Yes  
X: No



## 9. HISTORY

### THE STORY BEHIND THE ELECTRO 2 INSTRUMENTS

The Nord Electro 2 is a stage keyboard focused on vintage instrument sounds -- specifically, sounds from popular electromechanical keyboards produced from the '50s to the '70s. These instruments are no longer in production, but they continue to play a remarkably important role in music today. In this chapter, we will focus on these instruments. For those of you who aren't familiar with these instruments, we will give you a description of the principals of each instrument and its basic design theory, as well as short histories of the instruments. For all of you interested in digging even deeper into these instruments, we will recommend some nice literature to read further about them (see the end of this chapter).

#### WHAT IS AN 'ELECTROMECHANICAL' INSTRUMENT?

One in which some sort of electric pick-up system, either electromagnetic or electrostatic, detects and amplifies certain mechanical movements. The source of these movements can be a spinning tone wheel or the vibrations of a reed, string, or tine.

#### HOW DOES AN ELECTROMECHANICAL PICK-UP WORK?

The pick-up system in a Electric Piano is electromagnetic. When you play a note on a Electric Piano, a metallic tine vibrates and changes the magnetic field around a coil that picks up the vibration. These vibrations are slightly amplified to create a musical tone.

The Hohner Clavinet has real strings inside. The vibrations of each string are picked up by an electromagnetic pick-up similar to the magnetic pick-ups of an electric guitar.

An electromagnetic pick-up system is also used in tone wheel Hammond organs such as the famous B-3. A tone wheel is a rotating disc with notches around its edge. Positioned as close as possible to each of the 96 tone wheels in a B-3 is a magnetic pick-up. Every time a notch passes the pick-up, a change will occur in the magnetic field, which will induce a small voltage in the pick-up. The number of notches in the wheel and its rotation speed determine the pitch of the tone produced.

Wurlitzer electric pianos uses an electrostatic pick-up system. A DC voltage is applied between vibrating reeds and a metal plate placed near the end of the reed. As the reed vibrates, it varies the capacitance between the metal plate and the reed. These changes will generate an electrical signal - the tone (see the schematic figure to the right).

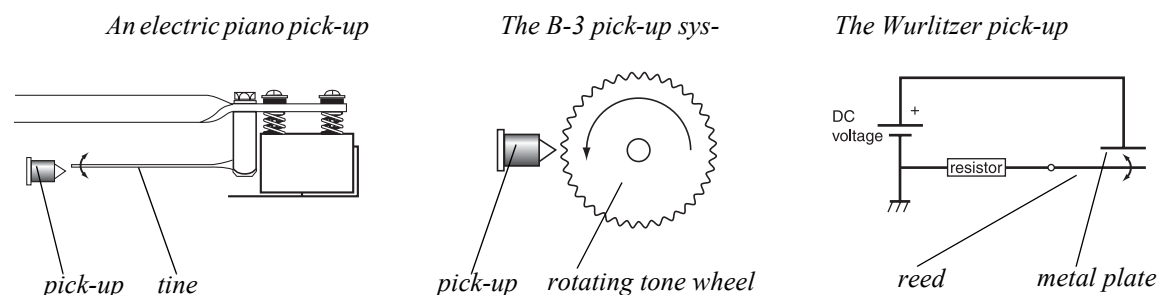

### THE ELECTRO 2 ORGAN SECTION

The organ chosen for the task to be simulated was a Hammond A-100. Except for its cabinet and the inclusion of a built-in sound system, the A-100 works the same as Hammond's almighty rock 'n' roll organ, the famous B-3. The Hammond organ was originally designed to be an alternative for churches instead of large acoustic pipe organs. In the '30s, there was a growing demand for more compact organs that sounded similar to pipe organs because small churches couldn't afford or didn't have the space to install a big pipe organ. The Hammond organ was designed with drawbars for sculpting the harmonic content of the organ sound. They function much like stops on a pipe organ. This was the standard, and so it became (see figure to the bottom right of this page).



*This is the Hammond A-100 organ that is simulated by the Nord Electro 2. The A-100 is electrically similar to the B-3 and C-3 organs, but it features a different cabinet and has a built-in amplifier, speakers, and spring reverb. This particular unit left the factory on June 2, 1965. The A-100 was taken out of production four months*

**THE HAMMOND ORGAN COMPANY STORY**  
Has any other keyboard instrument created as much interest as the Hammond organ? The model emulated by the Nord Electro 2 is the B-3, the most popular version of all Hammonds produced. Between their release in 1954 and 1974 when they went out of production, nearly 275,000 B-3 and C-3 organs were built. (The C-3 is identical to the B-3 except for its cabinet design; Hammond didn't keep separate records for the two models.) No other electric keyboard in the world has exceeded that number -- so far.

It started in the early 1930s, when inventor Laurens Hammond was looking for different applications for a 60-cycle motor he had designed for his clock factory. An earlier inventor named Thaddeus Cahill had, at the beginning of the 20th century, made an electromechanical instrument called the Telharmonium, which later caught the attention of Hammond. Although he wasn't a musician, Hammond was attracted by the idea to build a genuine electric musical instrument. Hammond had a degree in mechanical engineering and had developed great skill in mechanical design. In his lab, Hammond and his assistants designed and built an electromechanical organ based on Cahill's principles. The basic components of the organ were tone wheels and electromagnetic pick-ups, and the instrument is acknowledged as being of excellent mechanical design for its time.

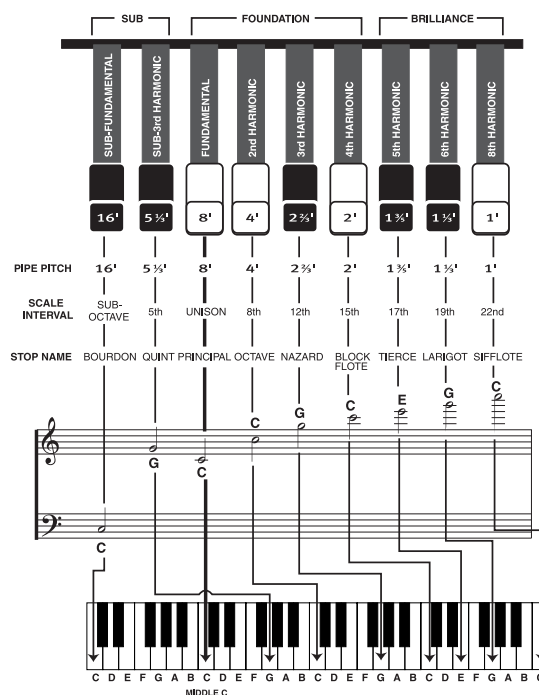

Hammond filed a patent for the tone wheel organ in 1934, and one year later he introduced the first Hammond organ, the Model A. In the patent, Hammond catalogues the numerous objects that contribute to the complete design. He lists 29 different features. Among them you can find, for example, feature number 17, which states: "To provide an instrument of the type which is relatively light in weight and is portable." Wonder what roadies around the world have to say about that!

This patent is the backbone of the whole organ line made by Hammond until 1974. The Model A was very expensive at the time, yet the sales were impressive. The company grew steadily and, over time, new models were released. Laurens Hammond was correct from the start to have focused his market for the instrument on churches. He saw a great potential there in sales, and many organ models had cabinets designed to fit the various religious services. Despite all-new models, they had more or less the same tone-wheel concept, but with different styles of cabinets, pedal board, speaker configuration, and amplification. Hammond and his team continued to experiment with different ways to deepen the sound, adding effects such as tremolo and chorus.

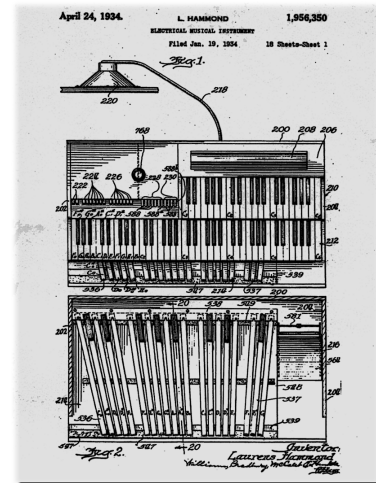

The first page of the patent for the tone wheel organ filed by Laurens Hammond in 1934.

In 1954, Hammond introduced the B-3 model to the market. It became the best seller of all Hammond organs. One of the secrets to the B-3's success was its sound, thanks to the integration of the newly developed chorus and tremolo features, as well as the introduction of the Percussion feature and reverberation. All this combined made musicians do a vast amount of new and exciting sounds to play with at the time. The B-3 is still a very popular instrument and still in use around the world.

Here you can see the knob for selecting the A-100 organ's Vibrato and Chorus effects. There are six different positions. All of these effects are simulated in the Nord Electro 2. The rocker tabs control the Vibrato/Chorus on/off status for the upper (Swell) and lower (Great) manuals. The tab far to the left is a overall volume switch for the whole organ. This particular function is not exactly implemented in the Nord Electro 2. Instead, there's a Master level



On the right-hand side of the A-100, there are the Percussion tabs. These are all simulated in the Nord Electro 2. The Percussion feature is a single-trigger/non-legato effect. Enabling the Percussion on/off switch disarms the 1' drawbar on the A-100. In the Electro 2, the 1' tone will still be available if desired. The idea with this effect was to add an attack transient to the tone of the organ. There above the fundamental (8') -- named the "second" harmonic -- or the octave and a fifth above -- named the "third" harmonic. The Slow/Fast tab defines the release envelope of the percussion effect. This is a great feature that was released in 1954, letting the player give an extra little edge to the solo parts he or she is playing.



On the left-hand side of both manuals, Hammond tone wheel organs have one octave of reverse-colored keys. These don't trigger notes; instead, they call up preset drawbar settings. All tone wheel Hammonds have double manuals.



What you see here isn't an original component on a Hammond organ; it's an add-on. It's the controller switch for the Leslie rotating speaker cabinet. Slow rotation speed is called Chorale, and fast speed is called Tremolo. In the Nord Electro 2, the Leslie speaker effect is simulated with this kind of controller.

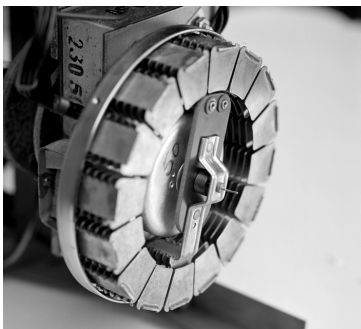

This is the inside of the famous Vibrato and Chorus scanner. It was designed by John Hanert, Hammond's #1 engineer. Hanert was the designer of many patented components in Hammond tone wheel organs. The scanner was attached to the drive shaft that all of the tone wheels were fit upon, just behind the

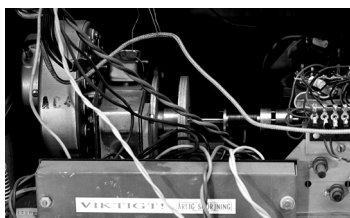
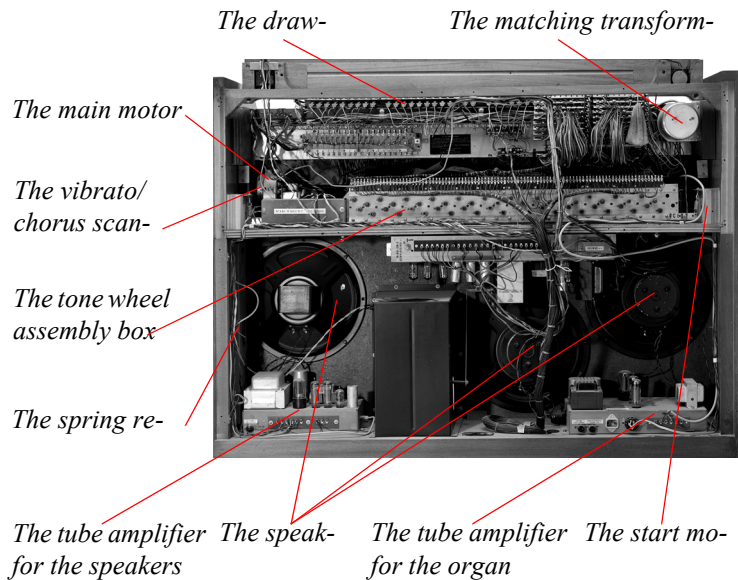

A close-up view of the main 60Hz motor. The vibrato scanner is mounted on the left side.



This is the inside of the drawbars. Underneath, you can vaguely see some of the coils for the magnetic pick-ups.



A close-up picture of the speaker tube amplifiers.

*Here is a picture of the inside of the Hammond tone wheel box. It's the basic design that elevated Hammond to the top of the organ manufacturer mountain. Each note on the Hammond corresponds to a tone wheel. Every tone wheel has its own pick-up comprising a magnet with a coil. The pitch of the sine wave generated by a tone wheel is determined by the number of notches on the edge of the wheel and the wheel's rotation speed. Every time a notch in the wheel passes the magnetic field, it induces a voltage in the coil. The more notches and the faster they pass, the higher the pitch.*



Laurens Hammond retired at age 65 in 1960 and passed away in 1973. One year after his death, the factory stopped making tone wheel organs. From then on, the only organs that were produced had electric circuits -- but that's another story.

#### **THE LESLIE SPEAKER**

The rotating speaker effect in the Nord Electro 2 is a digital emulation of the Leslie 122 speaker cabinet. Leslie cabinets are stand-alone devices. Their preliminary design was to amplify and add modulation effects -- i.e., chorus and tremolo -- to the sound generated by an electric organ such as those made by the Hammond Organ Company.

What's the story behind this famous accessory to the Hammond organ? It goes back to 1937, when musician and inventor Don Leslie bought a Hammond Model A. Don was interested in finding a musical instrument that could sound like a pipe organ, and he decided to buy the Hammond because he figured it sounded close enough. To save money, he chose not to invest in an accompanying Hammond tone cabinet because he thought he could make his own speaker system.



*Leslie 122 rotating-speaker cabinet.*

However, he wasn't satisfied with the organ sound coming from his first fixed-speaker design because the sound was too static. He wanted to create some kind of motion in the organ sound, much like the way the sound of a pipe organ moves around a big church because the pipes themselves are spread out across many large ranks - collections of pipes - that cover the frequency range across an organ console's keyboard manuals and pedal board. For several years, Don experimented with various combinations of speaker configurations and rotating components, and in 1940 he completed his first version of the rotating-speaker concept.



*A close-up view of the nice woodwork on a Leslie 122 speaker cabinet.*

He filed a patent application in 1940. Don Leslie met with Hammond representatives that same year and gave them the opportunity to buy his invention, but they refused. Instead, he started his own company and launched the product into the market under the name "Vibratone." In 1946 the name was modified to "Leslie Vibratone". Finally, in 1949, The name "Vibratone" was dropped and the models were named only "Leslie" after its inventor.

*The patent for the "Apparatus for imposing vibrato on sound" filed by Don Leslie in 1940.*

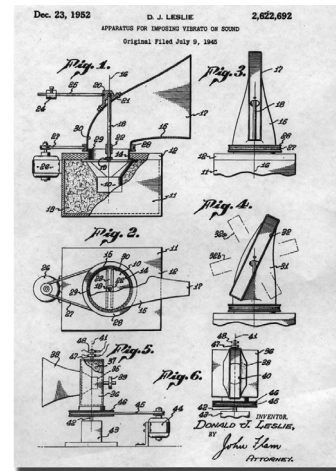

Over the years, Don Leslie improved the design and introduced a vast number of different models. In 1963, he began shipping the Leslie 122 cabinet and it became the most popular model. The basic principle behind the Leslie 122 is the incorporation of two rotating objects. One is a spinning drum with a deflector mounted beneath a downward-facing 15" speaker for bass frequencies -- those below 800Hz. Higher up inside the 122 is a compression horn-driver attached to a rotating dual-bell horn assembly for mid range and treble frequencies. One of these horns is actually sealed; it's only there to serve as a counterbalance. Therefore, you only hear higher frequencies emanating from the open-ended bell. The sound is amplified by a 40-watt tube amplifier. The 122 also features two rotation speeds: The slow speed, which creates a chorus effect, is known as "chorale," and the faster speed was named "tremolo." Switching between these two speeds at musically appropriate times creates a wonderful -- and even emotional -- effect.



*Inside a Leslie 122. Each rotor has its own motor. A 40-watt tube amplifier drives the speaker components.*

Don Leslie, who turned 91 in 2002, estimates that around 200,000 original Leslie 122 cabinets were built in total. Laurens Hammond himself never liked the Leslie cabinet and refused to have anything to do with this product. Instead, he tried to manufacture other solutions hoping he would make the Leslie obsolete, but he never succeeded. The Leslie speaker was an instant success. Pairing a Leslie with a Hammond organ proved the perfect match, and this combination became a "must have" for many Hammond organ players.

*The treble horns in a Leslie 122. One horn is a dummy to give the right a balance during rotation. Only the horn rotates; the horn driver remains stationary. At the mouth of the horn is diffuser cone which widens the dispersion to give a "more musically pleasing tone".*



*The bass drum. The deflector inside the drum isn't visible. A thin cloth covers the round drum. The Leslie 122's 15" speaker doesn't rotate. It remains stationary while the drum spins.*



### THE WURLITZER EP

The next instrument to be sampled for the Nord Electro 2 is the Wurlitzer electric piano model 200. What became the Wurlitzer electric piano was originally designed by Benjamin Franklin Miessner, born in 1890. An American inventor who became involved with innovations in radio during his early years, Miessner designed an electro-acoustic instrument pick-up in 1921. A company called Amperage manufactured it for guitars in 1928. After selling his radio patents to RCA in 1930, Miessner set up a laboratory to develop his ideas on electrifying musical instruments with the goal of creating small, affordable electric pianos for educational use. He experimented with ways of amplifying the strings in an acoustic piano that lacked a sound board, and he filed a patent for this design in 1931. Miessner continued to develop his theories and give the piano a more powerful tone. He began incorporating metal reeds in place of strings because the reed timbre and the decay of their vibrations sounded superior to the muddy quality of the soundboardless strings.



*A Wurlitzer 200A electric piano -- the most popular Wurlitzers model ever built. If you compare a Wurlitzer with other electric pianos, you find the Wurlitzer a little more compact. The Wurlitzer came with 64-note range A to C.*

At this point Miessner's concept garnered lots of interest from piano manufacturers around the country. His ideas reached the big jukebox and organ company, Wurlitzer, where someone realized the invention had great potential. Wurlitzer bought the patent and the rights to make this instrument and immediately started the development of an electric piano. They wanted to produce an electric piano, but with a more piano-like action and sound. The basic design incorporated felt-dressed hammers similar to those in an acoustic piano to stroke the metallic reeds. The vibrations from the stroke on the reeds produced a big, fat, rich tone, which was sensed by the electro-static pick ups, amplified and routed to the built-in speakers on the front of the piano. In the patent text from 1959, which Miessner had originally filed in 1950 with Wurlitzer as the assignee, you can understand his intentions and design goals. He wanted to built a compact, lightweight instrument with a real piano action. It was also important that the piano sound like an acoustic piano. Miessner declared that his invention would solve the tuning problems associated with acoustic pianos.

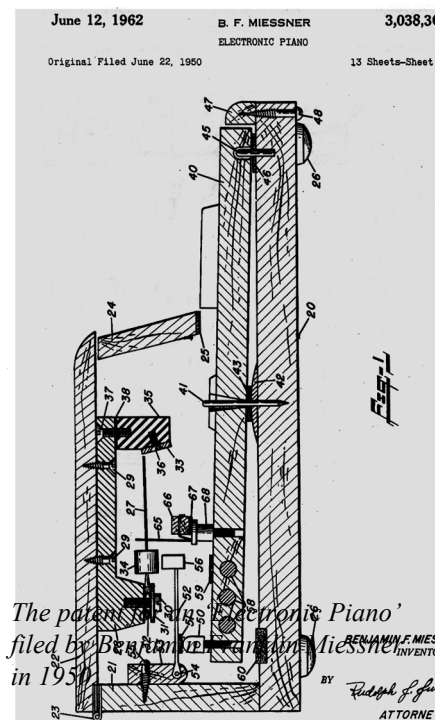

The first electric piano released by Wurlitzer was the model 100, which came to the market in 1954. It was an instant success. The Wurlitzer Company realized the instrument's potential in music education and offered many special educational models. Miessner's basic design was the backbone of the product, but one problem remained: It was very difficult to keep a 100-series electric piano in tune, and this problem definitely needed to be solved.

The tuning artifact that plagued early Wurlitzer electric pianos wasn't solved until the release of the 200 series in 1968. The Wurlitzer 200 was constructed better mechanically and is the model most known on the rock scene. It became a huge success and was produced until 1982.

The Wurlitzer sampled by Clavia's is a model 200A. Unfortunately, there is no record of the year it was built.

*A peekaboo look inside a Wurly 200A. The Wurly has its own built-in pre-amplifier and two speakers facing the player.*

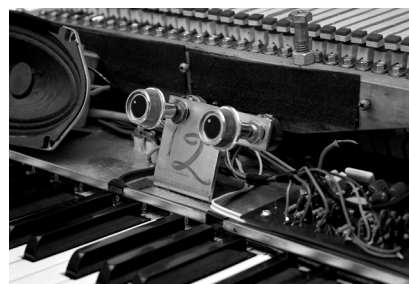

*The metal reeds in a Wurly. Here you can see the electrostatic design where two metal plates are connected via a capacitor and a load resistor. When the reed vibrates, a voltage applied across a load resistor will produce a signal that generates a musical tone. This tone is fed through the internal amplification to the instrument's line output. Note the dampers that reside above the reeds. On the high-pitched notes,*

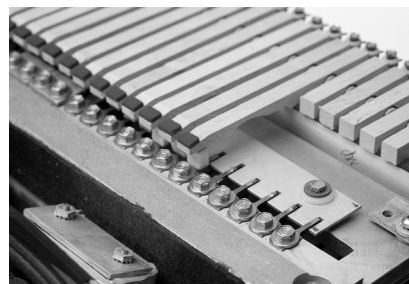

*From this angle, you can see the piano-style mechanics with felt-covered hammers that Wurlitzer electric pianos featured.*



*On a Wurlitzer 200A, you have a Volume control and a Tremolo knob. The Wurly has an internal amplifier and two built-in speakers.*



## THE HOHNER CLAVINET

The Clavinet is another story. It's based on strings and guitar pick-ups. Ernst Zacharias designed the Clavinet during the mid-'60s and filed his patent in 1966.

Previously, Zacharias had designed an instrument called the Cembalet -- a keyboard that used accordion reeds as the tone source. This instrument was very popular at the time and was in production for ten years. Hohner released the Pianet L -- an electrified metal-reed piano -- in 1962. In 1977, the company introduced another version called the Pianet T, which was the cheapest, most popular, and final model of the Pianet series.

While designing and building the Pianet series, Zacharias also worked on another project. As he was very interested in early keyboard music, he investigated the clavichord to see if he could make an electric version. This work finally resulted in the Hohner Clavinet I. It was primarily designed as a home instrument for playing baroque or classic music. Of course later history proved that this instrument instead had a huge impact on the rock/funk keyboard player.

The mechanics of the Clavinet is similar to what happens in an electric guitar, and offers a distinct powerful attack. Thanks to the keys is in direct applied to the hitting the string fast rhythm patterns. Unfortunately, the first Clavinets were difficult to play in high-volume situations because of major feedback problems.



*A Hohner Clavinet D6. The sound of this instrument was made famous thanks to the fabulous Stevie Wonder song "Superstition".*

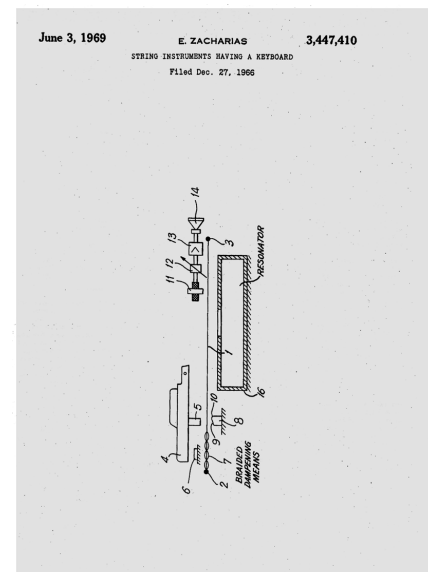

*The front page of Ernst Zacharias' patent for 'String Instruments Having a Keyboard' filed in 1966.*

Hohner unleashed the Clavinet C in 1968. This version features a slimmer design and better served the live keyboard player on stage. Its sales shot rocket-high. In 1971, the Clavinet D6 was launched. It became the most popular model. The D6 sported 15 different filter settings, four different microphone settings, and a mute function to dampen the strings. An improved internal string-dampening feature also reduced the acoustic feedback problem.

The last of the Clavinets -- the E7 -- appeared in 1977. It was especially designed to be taken on the road by rock bands. The E7's insides were the same as the D6, with the addition of a special filter to reduce interference from light dimmers and other electric equipment used on stage. Unfortunately, this filter proved detrimental to the Clavinet's higher frequencies, which was a serious drawback for the sound quality.

At that point, polyphonic synthesizers began appearing on the market and the Clavinet was no longer popular. Its production ended in 1980.

*Under the Clavinet's hood. In the front, you'll notice the damping mechanism after the Neck pick-up. Beneath the keys under the strings, you can see the Bridge pick-up. The strings are mounted on a metal body that's fastened into the wood cabinet.*

*This is the lowest key on a Clavinet D6. The green material is yarn, which serves to dampen and avoid feedback. The little round detail under the key is the tangent with the rubber tip that hits the string. Underneath the string is an anvil. The Clavinet strings are more plucked than struck.*

*Directly from the front. The hammers are mounted beneath the keys. Each hammer has a rubber tip that hits a string. Each tangent has a corresponding anvil beneath the string. When the tangent hits a string, the string will vibrate. The screws serve to tune the strings.*



*Hohner's Clavinet D6 has a pre-amplifier featuring four different filters that can be fixed to 16 different settings as well as four pick-up variations. In total, there are 64 different sound combinations -- which are all simulated in the Nord Electro 2.*

*The four fixed filters are designated Brilliant (high-frequency), Treble (high-mid), Medium (mid-low), and Soft (bass). The Pick-up settings are a combination of the two pick-ups in the Clavinet. With the B and C buttons activated, the Bridge pick-up is chosen -- which provides a warmer sound. When the A and C buttons are activated, the signal is fed through the Neck pick-up, giving a brighter sound. The combination A and D activates both microphones, making the sound more full-bodied. Finally, with the B and D buttons activated, the signal gets routed through the Bridge and Neck pick-ups set out of phase, resulting in a thinner sound with less fundamental. The knob is the volume control.*

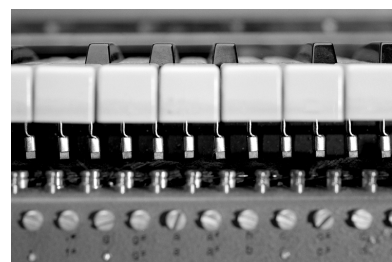

**BOOK SUGGESTIONS**

The A-Z of Analogue Synthesizers Part One: A-M (Revised) & Part Two: N-Z, by Peter Forrest (Susurreal, Star House, Sandford, Crediton, Devon EX17 4LR, England; +44-1-363-774627; pforrest@mail.eclipse.co.uk; also available from Keyfax, www.keyfax.com)

The Hammond Organ: Beauty in the B, by Mark Vail (2002, 2nd edition; ISBN 0-87930-705-6)

Keyfax: 2, 4, and The Omnibus Edition, by Julian Colbeck (Keyfax, 505 River St., Santa Cruz, CA 95060; 831-460-0172; www.keyfax.com)

Vintage Synthesizers, by Mark Vail (2000, 2nd edition; ISBN 0-87930-603-3; Backbeat Books, www.backbeatbooks.com)

**WEB SUGGESTIONS****WURLITZER ELECTRIC PIANO**

<http://my.stratos.net/~riderz/wurlitzer.html>

**CLAVINET D6**

<http://www.clavinet.com>

**HAMMOND TONE WHEEL ORGAN**

<http://theatreorgans.com/grounds/docs/hamco.html>

<http://theatreorgans.com/hammond/faq/mystery/mystery.html>

**MUSIC SUGGESTIONS****WURLITZER ELECTRIC PIANO**

Supertramp "Crime of the century"

George Benson "Absolute Benson"

Donny Hathaway "Live"

**CLAVINET D6**

Stevie Wonder "Talking Book" (the song "superstition")

Foreigner "Urgent"

Commodore "Machine gun"

**HAMMOND TONE WHEEL ORGAN WITH LESLIE**

Joey DeFrancesco "Reboppin"

Jimmy Mcgriff "The countdown"

Jimmy Smith, various

Booker T Jones and the MG's, various



# INDEX

## NUMERICS

---

2nd, 3rd (Organ Percussion) 21

## A

---

Ac.Grand (Piano Type) 25  
Auto-Wah (modulation) 30

## B

---

Bank  
    selecting 12  
Bass (eq) 32  
buttons  
    using 16

## C

---

C1-C3 (Organ Chorus) 22  
Chorus (effect) 31  
Chorus (organ) 22  
Clav (Piano Type) 25  
    pickup and filter variations 26  
Config 36  
connections  
    audio 9  
    MIDI 9, 42  
    pedals 9  
control pedal  
    connecting 9  
    technical requirements 9  
    using 15  
controllers  
    dump 43  
    list (MIDI) 45  
    MIDI transmission and reception 41  
copy  
    Programs 18

## D

---

delete  
    Programs 18  
Display 7, 32

download  
    Programs via MIDI 18  
Drawbar 20  
    presets 20  
        store your own... 21  
    user presets 21  
Dump (Programs/Controllers) 39

## E

---

edit  
    Programs 16  
Effects section 28  
El.Grand (Piano Type) 25  
eq (Treble & Bass) 32  
erase  
    Programs 18  
expression pedal  
    connecting 9  
    technical requirements 9  
    using 15

## F

---

factory presets 40  
    restoring 40  
Fast (Rotary Speaker) 31  
Flanger (effect) 31  
front panel 7

## H

---

hard pan of outputs 24, 27, 37

## I

---

Instrument Select button 17  
internal memory 40  
Internet 6

## K

---

key click control (organ) 24, 37  
keyboard 8  
    split (organ) 22  
Keyboard Velocity  
    for Piano sounds 27, 38  
    MIDI 41  
knobs  
    using 16

**L**

---

- level
  - master 7, 32
  - output (individual per Program) 32
- Local (MIDI) 34
- Lower Ch 22, 34
- Lower Manual (organ) 22
  - using external MIDI keyboard 22

**M**

---

- Manual (Upper/Lower) 22
- Master Level 7, 32
- Master Tune
  - adjusting 35
- Mem Lock 35
- memory (internal) 40
- memory protect (Mem Lock) 35
- MIDI
  - about the implementation 41
  - basic settings 15
  - channel 34
    - Lower 34
  - channels
    - using with sequencer 42
  - connections 42
  - controllers
    - "chasing" when using a sequencer 42
    - list 45
    - recording in sequencer 42
  - implementation chart 48
  - Keyboard Velocity 41
  - local on/off 34, 42
  - Program Change 41
    - recording in sequencer 42
  - send all MIDI controllers 39, 43
  - Sysex dump of all Programs 43
  - Sysex dump of single Programs 43
  - Sysex reception of Program and Program Banks 44
  - using an external "lower manual" keyboard 22
- MIDI Ch 34
- Modulations 29

**N**

---

- Navigator buttons 7, 32
- Note On/Off
  - MIDI transmission and reception 41

**O**

---

- Octave Shift 12, 33
  - buttons 7
- Organ section 19
- OS upgrades 40
- output
  - level
    - master 7
    - physical 9
    - routing 24, 27, 37
- Output Level (individual per Program) 32
- Overdrive distortion 31

**P**

---

- Pan (modulation) 29
- Panic 39
- partials (organ drawbar) 20
- pdf file (reading the manual as...) 5
- Ped. Cnfg 14
- Ped. Pol 14, 36
- pedals
  - connecting 9
  - control/expression 15
  - Rotor Speed 14
  - sustain 13
  - swell 15
- Percussion (organ) 21
- Phaser (effect) 31
- Piano
  - downloading new instruments via USB 40
  - Type 25
- Piano section 25
- pitch bend MIDI messages 41
- Presence 26
  - with the Mega Clavinet sound 26
- Program
  - buttons 7, 33
  - copying 18
  - deleting 18
  - downloading from MIDI 18
  - editing 16
  - reverting to stored 17
  - selecting 12
  - storing 17
  - What is it? 16
- Program Change (MIDI) 41

**R**

---

rear panel 9  
E.Piano (Piano Type) 25  
E.Piano2 (Piano Type) 25  
RingMod (modulation) 29  
Rotary Speaker 31  
    controlling speed from pedal 31  
Rotor Speed pedal  
    connecting 9

**S**

---

save  
    Programs 17  
sequencing with Nord Electro 42  
Shift button 7, 33  
signal routing (internal) 11  
Slow (Organ Percussion) 21  
Soft (Organ Percussion) 21  
Split (Lower & Upper Manuals) 22  
Stop (Rotary Speaker) 31  
Store  
    button 7, 33  
store  
    Programs 17  
sustain pedal  
    connecting 9  
    settings 13  
swell 23  
    pedal  
        using 15

**T**

---

Transpose 13, 36  
Treble (eq) 32  
Tremolo (modulation) 30  
Tune (Master) 35

**U**

---

Upper Manual (organ) 22  
USB (for downloading Piano instruments) 40  
User Store 21

**V**

---

V1-V3 (Organ Vibrato) 22  
Velocity Sensitivity (piano sounds) 27, 38  
Vibrato (organ) 22

**W**

---

volume  
    individual per Program 32  
    master 7, 32  
Wah-Wah (modulation) 30  
Wur (Piano Type) 25

