

nord lead[®] 2X

virtual analog

User Manual Nord Lead 2X

OS Version 1.x



The lightning flash with the arrowhead symbol within an equilateral triangle is intended to alert the user to the presence of uninsulated voltage within the products enclosure that may be of sufficient magnitude to constitute a risk of electric shock to persons.

Le symbole éclair avec le point de flèche à l'intérieur d'un triangle équilatéral est utilisé pour alerter l'utilisateur de la présence à l'intérieur du coffret de "voltage dangereux" non isolé d'ampleur suffisante pour constituer un risque d'électrocution.

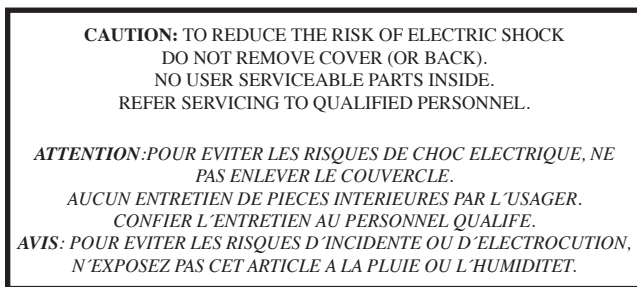

The exclamation mark within an equilateral triangle is intended to alert the user to the presence of important operating and maintenance (servicing) instructions in the literature accompanying the product.

Le point d'exclamation à l'intérieur d'un triangle équilatéral est employé pour alerter l'utilisateur de la présence d'instructions importantes pour le fonctionnement et l'entretien (service) dans le livret d'instructions accompagnant l'appareil.

Instructions pertaining to a risk of fire, electric shock or injury to persons.

IMPORTANT SAFETY INSTRUCTIONS

SAVE THESE INSTRUCTIONS

Warning - When using electric products, basic precautions should always be followed, including the following:

- 1) Read these instructions.
- 2) Keep these instructions.
- 3) Heed all warnings.
- 4) Follow all instructions.
- 5) Do not use this apparatus near water.
- 6) Clean only with dry cloth.
- 7) Do not block any ventilation openings. Install in accordance with the manufacturer's instructions.
- 8) Do not install near any heat sources such as radiators, heat registers, stoves, or other apparatus (including amplifiers) that produce heat.
- 9) Do not defeat the safety purpose of the polarized or grounding-type plug. A polarized plug has two blades with one wider than the other. A grounding type plug has two blades and a third grounding prong. The wide blade or the third prong are provided for your safety. If the provided plug does not fit into your outlet, consult an electrician for replacement of the obsolete outlet.
- 10) Protect the power cord from being walked on or pinched particularly at plugs, convenience receptacles, and the point where they exit from the apparatus.
- 11) Only use attachments/accessories specified by the manufacturer.
- 12) Use only with the cart, stand, tripod, bracket, or table specified by the manufacturer, or sold with the apparatus. When a cart is used, use caution when moving the cart/apparatus combination to avoid injury from tip-over.
- 13) Unplug this apparatus during lightning storms or when unused for long periods of time.
- 14) Refer all servicing to qualified service personnel. Servicing is required when the apparatus has been damaged in any way, such as power-supply cord or plug is damaged, liquid has been spilled or objects have fallen into the apparatus, the apparatus has been exposed to rain or moisture, does not operate normally, or has been dropped.



Additional Safety Information

No naked flame sources, such as lighted candles, should be placed on the apparatus;

Do not use the apparatus in tropical climates.

WARNING: To reduce the risk of fire or electric shock, do not expose this apparatus to rain or moisture.

The apparatus shall not be exposed to dripping or splashing and that no objects filled with liquids, such as vases, shall be placed on the apparatus.

The mains plug is used as the disconnect device and shall remain readily operable.

Il convient de ne pas placer sur l'appareil de sources de flammes nues, telles que des bougies allumées;

L'appareil n'est pas destiné à être utilisé sous un climat tropical.

L'appareil ne doit pas être exposé à des égouttements d'eau ou des éclaboussures et de plus qu'aucun objet rempli de liquide tel que des vases ne doit être placé sur l'appareil.

Lorsque la prise du réseau d'alimentation est utilisée comme dispositif de déconnexion, ce dispositif doit demeurer aisément accessible.

Trademarks: The Nord logo is trademark of Clavia DMI AB. All other trademarks mentioned in this publication are the properties of their respective holders.

Specifications and appearances are subject to change without notice.

Copyright © Clavia DMI AB



TABLE OF CONTENT

1. INTRODUCTION	7
WELCOME!	7
ABOUT THIS MANUAL	7
Reading the manual in Adobe Acrobat Reader.....	7
CLAVIA ON THE INTERNET	7
 2. CONNECTIONS	 8
INPUTS AND OUTPUTS.....	8
CONNECTING PEDALS.....	9
 3. BASIC OPERATION	 10
DEMO PLAY FUNCTION.....	10
BASIC MIDI SETTINGS FOR THE NORD RACK 2X.....	10
The Trig button	12
SELECTING PROGRAMS	12
SELECTING PERCUSSION KITS.....	13
USING THE SLOTS TO SWITCH PROGRAMS.....	14
LAYERING	14
Activating	14
Deactivating	14
Polyphony	15
Changing Programs in the layer.....	15
SPLITTING THE KEYBOARD	15
Setting the Split Point.....	16
Combining Split and Layer.....	16
PERFORMANCES	16
MONOPHONIC AND POLYPHONIC OPERATION	17
STEREO/MONO.....	17
PITCH STICK AND MODULATION WHEEL	18
Pitch Stick	18
Modulation Wheel	18
MASTER TUNE	18
USING A SUSTAIN PEDAL	19
USING A CONTROL (EXPRESSION) PEDAL.....	19
THE “PANIC” BUTTON	21

4. EDITING PROGRAMS	22
CHANGING AN EXISTING PROGRAM.....	22
CHANGING ONE PROGRAM IN A LAYER.....	22
REVERTING TO THE ORIGINAL PROGRAM.....	22
USING MANUAL MODE	22
CUSTOMIZING MANUAL MODE.....	23
STORING PROGRAMS	23
COPYING PROGRAMS	23
5. PROGRAMMING VELOCITY SENSITIVITY	24
THE FILTER VELOCITY FUNCTION	24
MAKING ANY PARAMETER VELOCITY DEPENDENT	24
Setting the parameter ranges	24
Moving the range.....	25
CLEARING VELOCITY PROGRAMMING FOR ONE KNOB.....	26
CLEARING ALL VELOCITY PROGRAMMING	26
MORPHING	27
6. PERCUSSION KITS.....	28
SELECTING AND PLAYING A PERCUSSION KIT	28
EDITING THE SOUNDS IN A PERCUSSION KIT.....	29
SAVING PERCUSSION KITS	30
COPYING, EXTRACTING AND IMPORTING INDIVIDUAL PERCUSSION SOUNDS	30
SYSEX DUMPS OF PERCUSSION KITS.....	30
USING PERCUSSION KITS IN PERFORMANCE MODE	31
7. PERFORMANCES	32
WHAT IS A PERFORMANCE?	32
RECALLING A PERFORMANCE.....	32
EDITING A PERFORMANCE	33
Selecting Programs as base for a Performance.....	33
Layering and editing	34
Shift Functions	34
SAVING A PERFORMANCE.....	34
EXTRACTING SINGLE SOUNDS FROM A PERFORMANCE.....	35
EXITING PERFORMANCE MODE.....	35
WHAT A PERFORMANCE CONTAINS	36
For each Program Slot	36
For the entire Performance	36

8. PANEL REFERENCE	37
OSCILLATOR 1	37
Waveform selector	37
OSCILLATOR 2	39
Waveform selector	39
Semitones	41
Fine Tune	41
KBD Track	41
SETTINGS FOR BOTH OSCILLATORS	41
FM Amount	41
Ring Mod	42
Sync	43
Pulse Width	44
Mix	44
AMPLIFIER	44
Attack	45
Decay	45
Sustain	46
Release	46
ADSR Envelope behavior	46
Gain	47
FILTER	47
Filter Type	48
Frequency	49
Resonance	50
Envelope Amount	51
Velocity	51
KBD Track	51
Distortion	52
Attack, Decay, Sustain and Release	52
LFO 1	52
Waveform	53
Rate	53
Destination	53
Amount	54
LFO 2/ARPEGGIATOR	54
Arp switch	54
LFO 2: ARPEGGIATOR MODE	54
Rate	54
Arpeggio Mode	54
Arp range	55
Arpeggio Hold	55
About the Echo function	55
LFO 2: LFO MODE	56
Rate	56
Destination	56
Amt	56

MODULATION ENVELOPE	57
Attack.....	57
Decay.....	57
Amount	57
Destination.....	57
MOD WHEEL DESTINATION.....	59
Morph	59
LFO 1.....	59
Osc 2	59
FM	59
Filter.....	59
POLY, LEGATO, MONO	59
Poly	60
Legato.....	60
Mono.....	60
UNISON.....	60
PORTAMENTO	60
Portamento (Time).....	60
Auto.....	61
OCT SHIFT	61
Slot Octave Shift.....	61
Keyboard Octave Shift.....	61
9. SHIFT FUNCTIONS	62
ACCESSING THE SHIFT FUNCTIONS	62
Selecting a Shift function	62
SHIFT FUNCTION LIST	63
About Global and Slot Functions.....	64
Setting the value	64
Exiting the Shift functions mode	64
TUNE (MASTER TUNE)	64
OUT MODE.....	64
Settings for Slot A and B:.....	65
Settings for Slot C and D:.....	65
LOCAL.....	66
About Local Control and Control Change transmission	66
PROG/CTRL	66
Arpeggio and MIDI Out.....	66
MIDI CHANNEL	67
Slot MIDI Channel	67
Global MIDI Channel.....	67

SPECIAL	67
Accessing the Special functions	68
Function “1” – Synchronizing LFO 1 to MIDI Clock.....	68
Function “2” – Synchronizing LFO2/Arpeggio to MIDI Clock.....	69
Function “F” – External triggering of Filter envelope.....	69
Function “A” – External triggering of Amplifier Envelope	71
Function “S” – External Velocity Morph	71
Aftertouch and Expression Pedal Settings	72
SYSTEM.....	73
Sustain Pedal (SP).....	73
Pitch Bend Range (br)	73
Unison Detune (Un)	73
10. MIDI.....	74
 ABOUT THE MIDI IMPLEMENTATION	74
Notes.....	74
Pitch Bend.....	74
Controllers.....	74
Aftertouch	74
Program Change.....	75
Bank Select	76
System Exclusive.....	76
 USING NORD LEAD 2X WITH A SEQUENCER	76
Connections	76
Local On/Off.....	76
MIDI Channels	76
Program Change.....	77
Controllers.....	77
Some notes about Controllers and “Chasing”	78
 MIDI SYSEX BULK DUMP	78
11. SYNTHESIS BASICS	79
 INTRODUCTION.....	79
 THE “BUILDING BLOCKS”.....	79
Oscillator.....	79
Filter.....	79
Amplifier	79
Envelopes	80
LFOs	80
 CONNECTIONS	80
 THE OSCILLATORS AND WAVEFORMS	80
Pitch.....	80
Waveform.....	81

THE FILTER	85
Filter types	86
Roll-off	87
Cutoff frequency	88
Resonance	89
THE AMPLIFIER	90
ENVELOPES	90
ADSR-Envelope	90
AD-Envelope	93
LFOS	93
12. FACTORY PRESETS	94
PROGRAM BANKS 0-3	94
PROGRAM BANKS 4-7	95
PROGRAM BANKS 8-9	96
PERCUSSION KITS	96
PERFORMANCE BANKS 0-1	97
PERFORMANCE BANKS 2-3	98
ABOUT THE ORGAN SOUNDS	99
Drawbar Organ Essentials.....	99
ABOUT THE PROPHET-5 SOUND RECREATIONS	101
NORD LEAD 2 RAM FACTORY PROGRAMS	102
13. MIDI IMPLEMENTATION	103
MIDI CONTROLLER LIST	103
SYSTEM EXCLUSIVE IMPLEMENTATION	105
General Message format.....	105
Patch Dumps	105
Percussion Kit Patch Dump.....	106
Patch Dump Request.....	107
Performance Dump	108
Performance Dump Request.....	109
All Controllers Request.....	109
Patch and Performance Data Formats.....	110
MIDI IMPLEMENTATION CHART	113
INDEX	115

1. INTRODUCTION

WELCOME!

We'd first like to thank you and congratulate to the purchase of a Nord Lead 2X. You're about to begin a journey into the world of *virtual analog* synthesis. *Analog* because the Nord Lead 2X mimics traditional analog synthesizers in a way no one thought was possible. *Virtual* because the Nord Lead 2X is actually a digital instrument, remaining true to the traditional analog concept, and still managing to go beyond it! But not all the magic lies in the sound creation. A major part is in the front panel, comprehensive, clearly laid out and smooth to operate.

ABOUT THIS MANUAL

If you have some basic knowledge about programmable analog synthesizers, you probably won't need this manual much. Therefore, it's arranged mainly as a reference manual for those rare situations where something isn't as obvious as it should be.

Every time this manual wants your attention to an object on the synthesizer, the name of that object will be printed LIKE THIS, e.g. 'click on the STORE button'. The LED display on Nord Lead 2X is always referred to as the DISPLAY. Whenever there is a reference to the 'keyboard', that reference will also apply to any incoming MIDI notes.

READING THE MANUAL IN ADOBE ACROBAT READER

This manual is also available as PDF file. It can be downloaded, free of charge, from Clavia's web site at <http://www.clavia.se>. When reading the manual as PDF file, you will need Adobe Acrobat Reader 4.0 or later. This program can be downloaded, free of charge, at <http://www.adobe.com>.

With Adobe Acrobat Reader it is possible to use special navigation features like hyperlinks. This means that you can click with the mouse on a word or sentence and automatically get to the location indicated by the word/sentence. To better show what words or sentences are hyperlinked in this manual, these words are written in [magenta](#).

CLAVIA ON THE INTERNET

If you have access to the Internet, you're very welcome to visit <http://www.clavia.se>. There you will find the latest information about Nord Lead 2X and other Clavia products. In the future you'll also be able to download new Nord Lead 2X sounds, free of charge.

2. CONNECTIONS

INPUTS AND OUTPUTS

- Make all connections before turning on your power amplifier!
- If you are using a Nord Rack 2X together with a MIDI keyboard, connect a MIDI cable from MIDI Out on the keyboard to MIDI In on the Nord Rack.
- All signal cables used with the Nord Lead 2X must be shielded.
- All four Outputs (A-B-C-D) are unbalanced, line level.
- If you connect the Nord Lead 2X in stereo to your audio equipment, you should use Outputs A and B. For mono connections, use Output A.

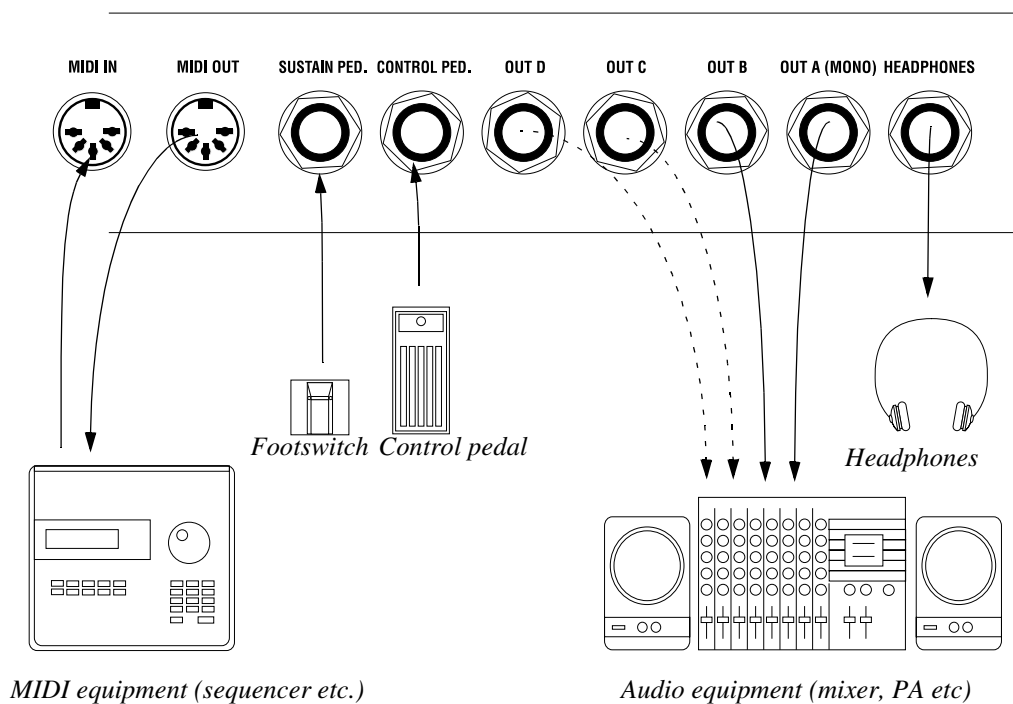

CONNECTING PEDALS

The Nord Lead 2X has two pedal inputs, one for a sustain pedal and one for a control pedal (an expression-type pedal, used to control various parameters in much the same way as the modulation wheel). Connect the pedals as shown in the figure below:

- When connecting an expression-type pedal to the Control Pedal input, you should use a stereo cable (Tip-Ring-Sleeve). Please note that the pedal must have a stereo output jack. The resistance range of the Control Pedal should be 10 kOhm to 50 kOhm

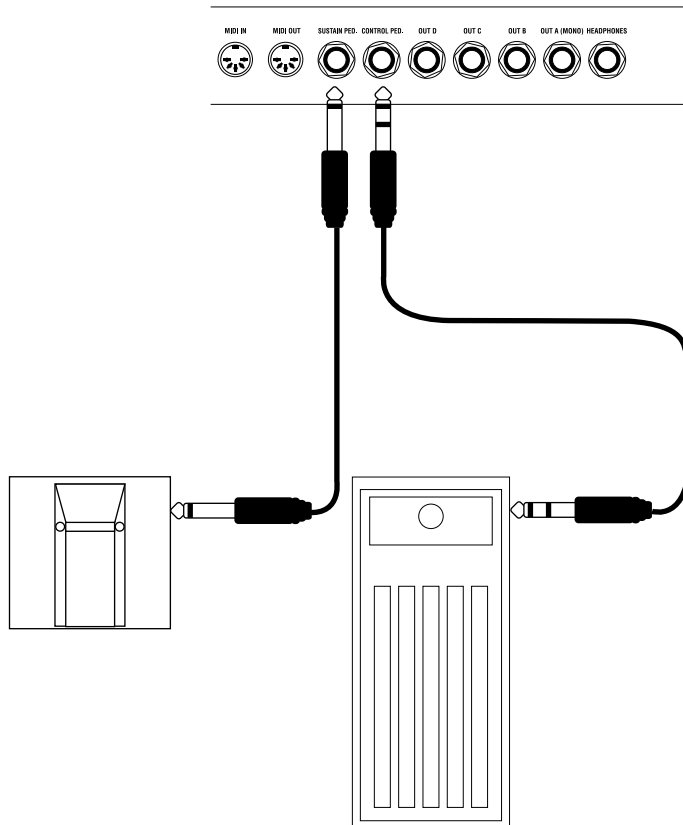

- For information on how to set the Nord Lead 2X up for use with sustain or expression pedal, see [page 19](#).

3. BASIC OPERATION

DEMO PLAY FUNCTION

Before you try out the new features for yourself, you may want to listen to what can be done with the instrument. The Nord Lead 2X is equipped with a built-in demo playback function. There are a number of demo songs in ROM, showing the instrument's versatility and features in different contexts. To listen to the demo songs, do like this:

1. Simultaneously press the **SHIFT** and **RING MOD/SYNC (Demo)** buttons.

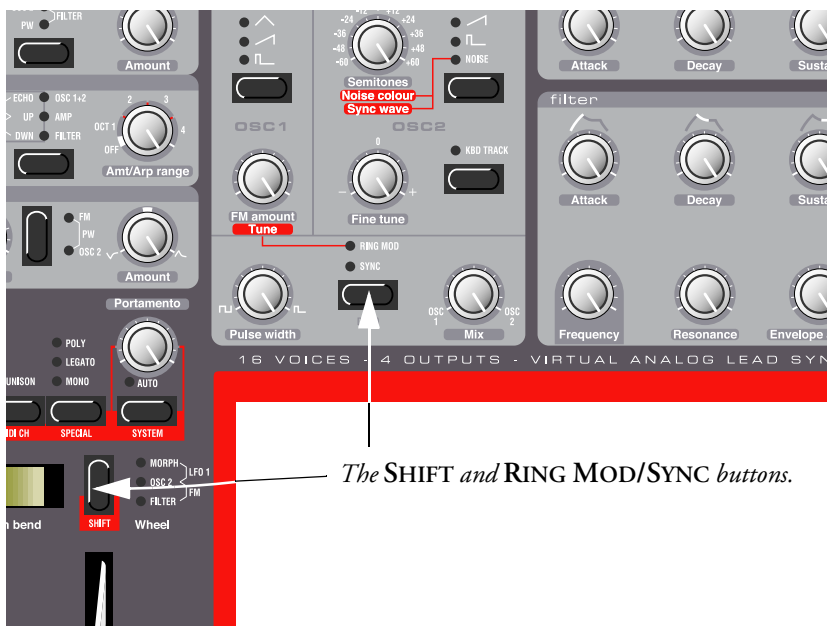

Playback starts. During playback, all knobs and buttons on the panel are disabled, except for **MASTER LEVEL**.

2. The demo songs are played back one after the other. If you want to move to the next or previous demo song, press the **UP** or **DOWN** button in the Program section of the panel.
3. To exit demo play mode, press any other button on the panel.

BASIC MIDI SETTINGS FOR THE NORD RACK 2X

If you are using the Nord Rack 2X and controlling it from a MIDI keyboard, the Nord Rack 2X must be set to receive on the same MIDI channel that the keyboard transmits on. To get started, proceed as follows:

1. Set the master keyboard to transmit on MIDI Channel 1.

2. Press the SLOT A button, so that the LED above the button is lit.

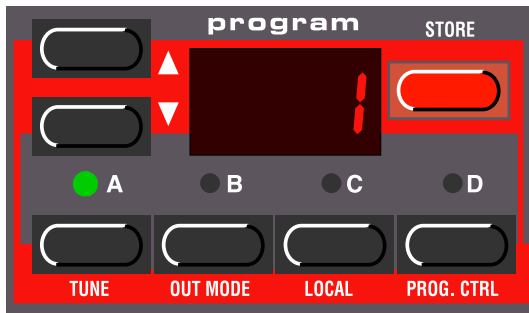

3. Hold down the SHIFT button and press the MIDI CH (Unison) button.

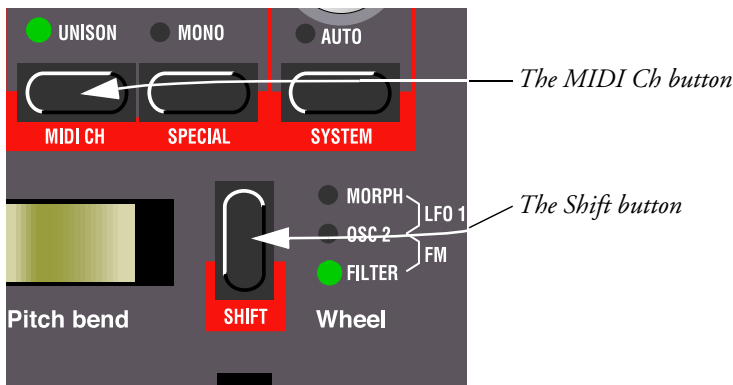

The DISPLAY will now show the MIDI Channel setting for Slot A (1 – 16 or off).

4. Use the UP/DOWN buttons to select MIDI Channel 1.

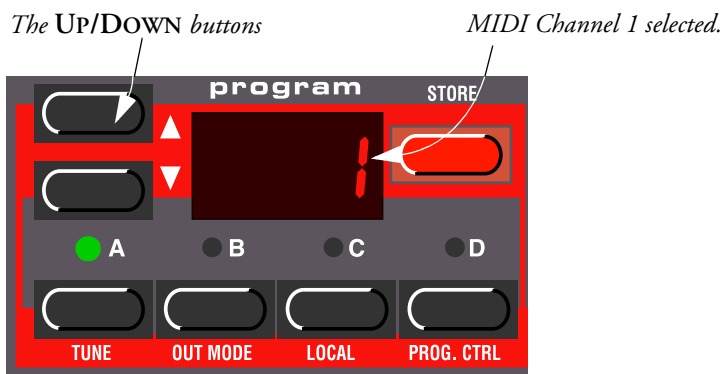

5. Press Shift again to return to the normal play mode.
If you use Slot A when you play the Nord Rack 2X (if you like, together with other Slots), this simple setting should be sufficient in most situations - even when playing Layers and Performances, as described later in this manual. For more information, see [page 76](#).

THE TRIG BUTTON

If you don't have a keyboard connected to your Nord Rack 2X, you can still try out the sounds by using the TRIG button. Pressing this button is equal to playing the note C3, with a velocity of 64.



The indicator next to the Trig button will light up every time the Nord Rack receives a valid MIDI Note message. This is an easy way to check that your MIDI connections are OK.

SELECTING PROGRAMS

Programs are sounds that you have prepared in advance. The internal memory in the Nord Lead 2X contains 10 x 99 Programs. The first four Banks (Programs 1-3.99) can be edited and overwritten with your own Programs, see below. There are also four Program Slots labelled A to D. The slots can be used for layering and quickly switching between Programs as described below. They are also used when the Nord Lead 2X is played via MIDI.

Note! The four Slots share the same internal memory, i.e. a given Program will sound the same regardless which Slot you load it to. You could actually load the same Program to all four Slots and edit them separately. However, as soon as you save the Program again to its original memory location from any of the Slots, the original Program will be overwritten.

1. Select a Program Slot to play by pressing one of the four buttons A to D. When you are only playing one sound at a time, as you are now, you can select any Slot.

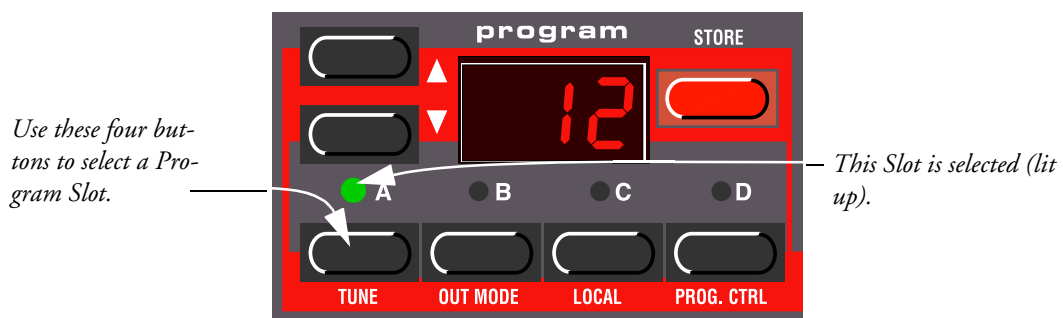

- Use the UP/DOWN buttons to select a Program for that Slot. Holding down a button scrolls the value quickly. Holding down the SHIFT button (the button above the MODULATION WHEEL) while pressing the buttons makes the value change in steps of ten.

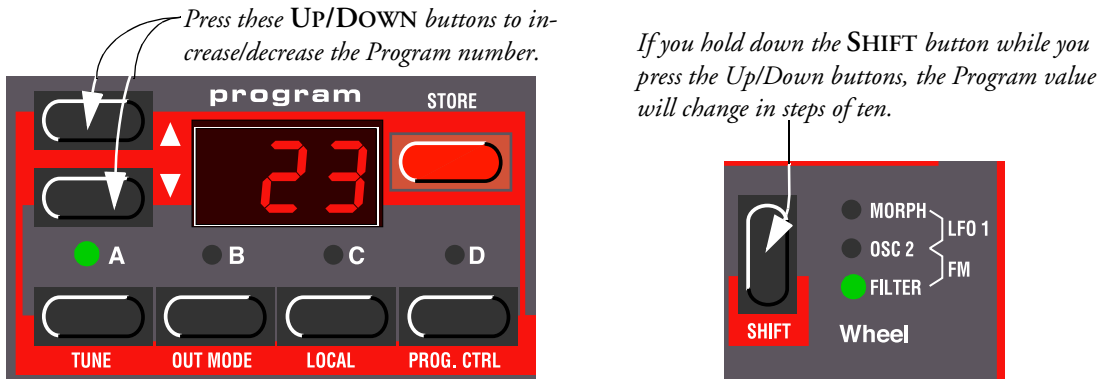

There are 10 x 99 Programs to select from (1-9.99). The Programs are arranged in ten Banks (0-9). The Programs in Banks 0-3 are rewritable, the rest are in ROM. The Bank number is indicated by the leftmost digit in the DISPLAY. The Bank number is not displayed for Bank 0, only for Banks 1-9:



Bank 0, Program 21



Bank 1, Program 21



Bank 2, Program 21



Bank 3, Program 21

SELECTING PERCUSSION KITS

In addition to the 10 x 99 Programs in the memory, there are 4 x 10 *Percussion Kits*. Each Percussion Kit consists of eight different virtual analog percussion sounds, arranged in zones across the keyboard. The Kits are located “above” Program number 99 in the Banks 0-3, and are numbered P0-P9. All Percussion Kits are overwriteable.

- To select a Percussion Kit for a Slot, proceed just as when selecting a regular Program: Use the UP/DOWN buttons to scroll to the desired Percussion Kit location.

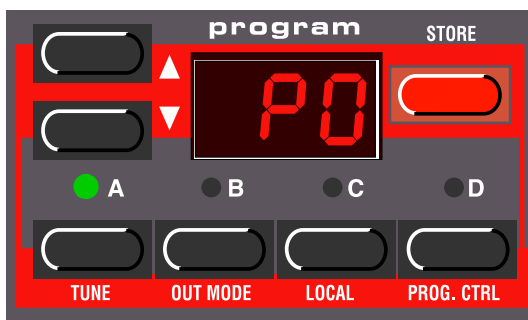

Percussion Kit P0 in Bank 0 is selected.

For detailed information about how to play and edit the Percussion Kits, see [page 28](#).

USING THE SLOTS TO SWITCH PROGRAMS

The four Program Slots A to D can be thought of as four temporary memories (edit buffers) that you can load Programs into for playing and editing. When you select one of the Slots you will switch to play the Program selected for that Slot. For live performance, for example, you can set up each Slot to play a different Program and quickly switch between them by pressing the SLOT buttons A to D.

Note! The four Slots share the same internal memory, i.e. a given Program will sound the same regardless which Slot you load it to. You could actually load the same Program to all four Slots and edit them separately. However, as soon as you save the Program again to its original memory location from any of the Slots, the original Program will be overwritten.

LAYERING

Layering means playing more than one Program at a time. On the Nord Lead 2X you do this by simply selecting more than one Slot. **Note that layering sounds works quite differently on the Nord Rack 2X.** On the Nord Rack 2X all Slots you want to be layered should be set to the same MIDI Channel. It doesn't matter which Slots are selected or not since all Slots respond to incoming MIDI data all the time.

ACTIVATING

Do like this to layer several Programs on the Nord Lead 2X:

1. Set up the Slots to play the Programs you want to use.
2. To activate more than one Slot, simply press all the SLOT buttons you want to use, at the same time. All LEDs of the Slots you selected light up. The one you pressed last is flashing. This is the Slot which will be available for editing from the front panel, but more on this on [page 22](#).

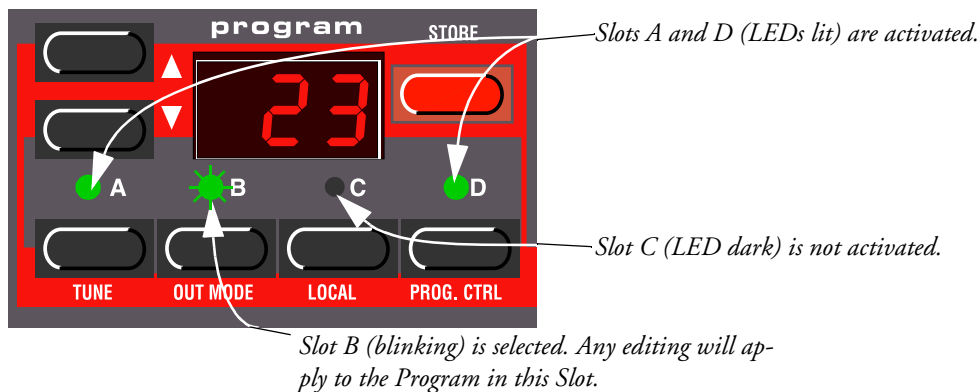

DEACTIVATING

To turn off the layer, press a slot button that is not part of the layer, or press all the buttons that make up the layer.

POLYPHONY

The Nord Lead 2X has 20 voices polyphony. How many notes you can play simultaneously depends on what Play modes and Unison settings the Program uses (see [page 59](#)) and also if you layer several Programs.

CHANGING PROGRAMS IN THE LAYER

If you want to select another Program for one or more of the Slots in the layer, do like this:

1. Press the Slot button that you want to select a new Programs for. Its LED will flash to indicate it is the *active* Slot.
2. Select a new Program for the Slot by pressing the UP/DOWN buttons.
3. Repeat the procedure if you want to change Programs in any of the other Slots in the layer.

SPLITTING THE KEYBOARD

The Keyboard Split function allows you to divide the Nord Lead 2X keyboard in two sections, each playing separate Programs. This can be very useful when you are playing live, since it lets you use the Nord Lead 2X as if it were two independent synthesizers, with different sounds. When Keyboard Split is activated, Slots A and B will be played from the left part of the keyboard, while Slots C and D will be played from the right part. Activate Keyboard Split like this:

1. Select Slot A and select a Program for it. This will be the sound heard when you play the left part of the keyboard.
2. Select Slot C and select a Program for it. This will be the sound heard when you play the right part of the keyboard.
3. Press the buttons for Slot A and C at the same time, so that one Slot LED is lit and the other one is flashing.
4. Press the **KBD SPLIT** button. The LED next to the button lights up to indicate that the keyboard is split.

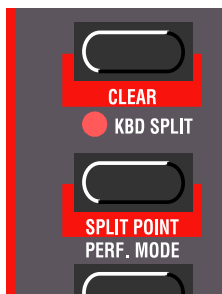

If you now play the keyboard, you will hear the sound of Slot A from the left part of the keyboard, and the sound of Slot C from the right part of the keyboard.

5. To exit the Keyboard Split mode, press the **KBD SPLIT** button again.

SETTING THE SPLIT POINT

You set the Split Point (the key where the keyboard should be split) in the following way:

1. Hold down **SHIFT** and press the **KBD SPLIT** button. The **DISPLAY** shows the current Split Point for as long as you keep both buttons depressed.

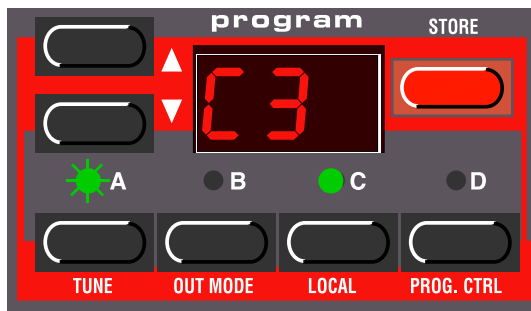

2. While holding down both the **SHIFT** and **KBD SPLIT** buttons, press the lowest key for the right-hand section of the keyboard. The **DISPLAY** shows the name of the key you press.
3. Release the **SHIFT** and **KBD SPLIT** buttons.

COMBINING SPLIT AND LAYER

Since Slots A and B will be played from the lower part of the split keyboard, and Slots C and D from the upper part, you can split the keyboard and play layers of two sounds on each keyboard half. Just select all Slots, and activate Keyboard Split.

PERFORMANCES

A Performance is a collection of up to four Programs, one for each Slot. Furthermore, the Performance contains information about which Programs should be active (layered), and settings for Keyboard Split. In fact, a Performance also contains information about what MIDI Channels to use for each Slot, and a number of other settings, but this is described more in detail on [page 32](#). This text is only meant as a quick introduction to playing the factory Performances.

1. If you have the Nord Rack 2X, make sure you transmit on MIDI Channel 1 from your master keyboard. This is because the factory Performances are set to receive on MIDI Channel 1.
2. Enter Performance mode by pressing the **PERF. MODE** button. The **DISPLAY** shows the latest selected Performance.

The Performances are organised in 4 Banks, each holding 100 Performances. The Performances are named alphabetically from A0-L9 in each Bank (the letters I and K are excluded because they're hard to show clearly in the **DISPLAY**). The Performances in the first Bank are rewritable and the rest are in ROM.

- To select a Performance, press the UP/DOWN buttons. (Hold down SHIFT and press the UP/DOWN buttons to jump between Performances in steps of ten.) The Performance is instantly loaded and you can try it out. For a list of the factory Performances, see [page 97](#).

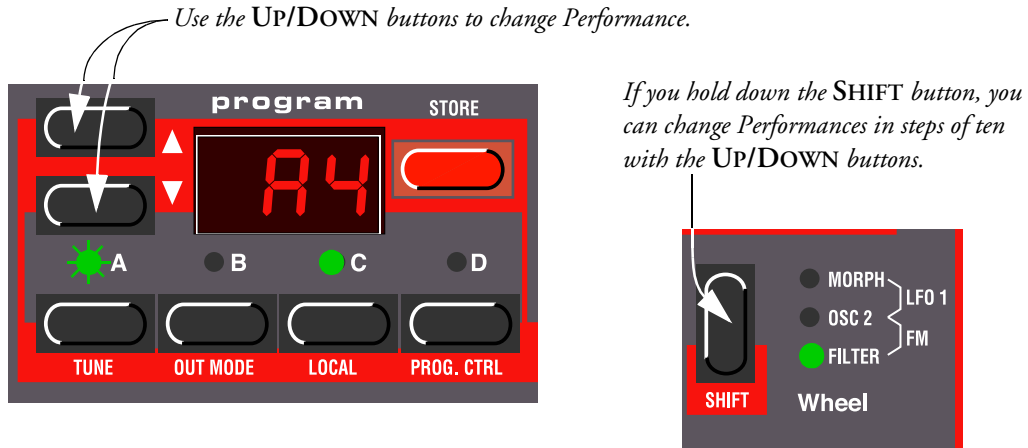

- Exit Performance mode by pressing the PERF. MODE button.

MONOPHONIC AND POLYPHONIC OPERATION

For each Program you can set a Play Mode (Poly, Mono, Legato). The exact nature of these modes is described on [page 59](#).

To make a sound fatter, you can activate Unison. This reduces polyphony. See [page 60](#) for details.

Press this button to turn Unison on and off. The LED above the button indicates that Unison is activated.

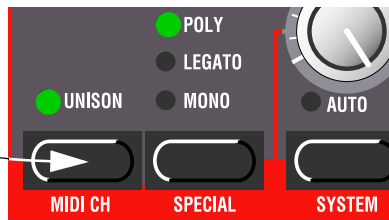

STEREO/MONO

If you are using more than one output, or headphones, you might want to know something about how the sounds get positioned in the stereo image.

The answer is that this depends on the Out Mode settings as described on [page 64](#). When shipped from factory, the Nord Lead 2X is set to output all Programs in mono. There's one exception: If a Program is set to Unison, the instrument is automatically switched to stereo operation.

PITCH STICK AND MODULATION WHEEL

PITCH STICK

The **PITCH STICK** is used to bend the notes, just as with a pitch bend wheel on traditional synthesizers. However, the **PITCH STICK** differs from other pitch bend devices in a couple of ways:

- There is no dead centre in the middle of the throw. This allows you to use the **PITCH STICK** for natural vibrato, pretty much like a guitarist do.
- The effect on pitch is logarithmic, that is, the further you move the **PITCH STICK** away from the center position, the more drastic the effect.

To set the range of the **PITCH STICK**, proceed as follows:

1. Hold down the **SHIFT** button and press the button labelled **SYSTEM**.

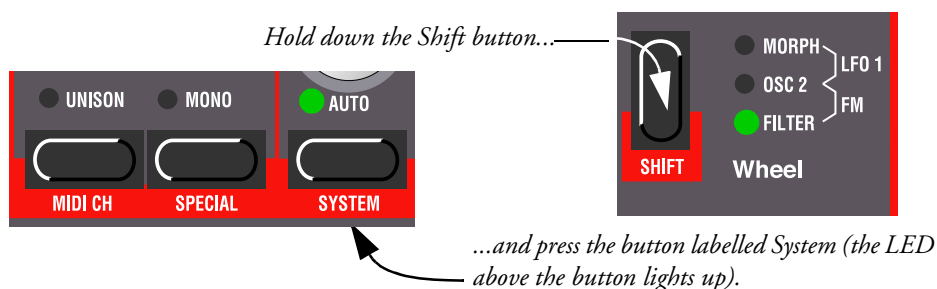

2. Press the **SYSTEM** button repeatedly until the character to the left in the **DISPLAY** says “br” (for Bend Range).
3. Use the **UP/DOWN** buttons to the left of the **DISPLAY**, to change the value. The table on [page 73](#) shows you how many semi-tones each value in the **DISPLAY** represents.

MODULATION WHEEL

The effect of moving the **MODULATION WHEEL** can be different for each Program. You can change the function by pressing the **SHIFT** button just above the **MODULATION WHEEL**. You can select between five destinations. A description of each can be found on [page 59](#).

MASTER TUNE

To tune the Nord Lead 2X to other instruments, do like this:

1. Hold down the **SHIFT** button and press the button labelled **Tune**.

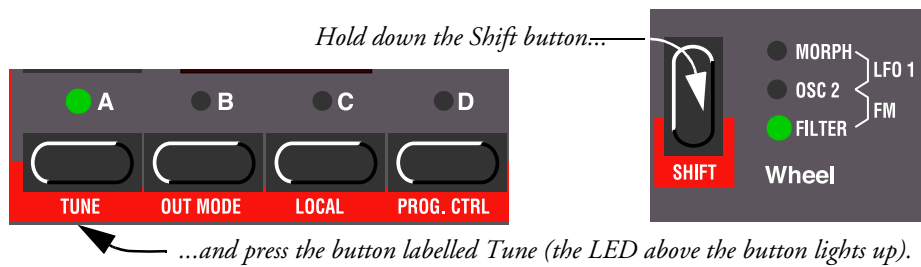

2. Use the **UP/DOWN** buttons to the left of the **DISPLAY**, to change the value. ‘00’ is normal 440Hz tuning. Lower pitches are indicated by a dot to the right of the number and values higher than normal pitch are indicated without a dot. The values are in cents (hundreds of a semitone).
3. Press the **SHIFT** button again.

USING A SUSTAIN PEDAL

A foot switch connected to the Sustain Pedal input works as a sustain pedal on a piano. Set it up the sustain pedal polarity like this:

1. Hold down the **SHIFT** button, and press the “**SYSTEM**” button until the two first digits in the **DISPLAY** reads ‘SP’.
2. Use the **UP/DOWN** buttons to switch the rightmost digit between ‘0’ (Sustain Pedal – open when depressed) and “1” (Sustain pedal – closed when depressed).
3. Press the **SHIFT** button again.

Nord Lead 2X will also recognize Sustain Pedal MIDI messages as MIDI Controller #64.

USING A CONTROL (EXPRESSION) PEDAL

As indicated in the illustration on [page 9](#), a regular expression pedal can be connected to the Control Pedal input, using a stereo cable. The connected pedal will either duplicate the **MODULATION WHEEL** functionality or independently control one of a number of parameters. You can select different Control Pedal functions for each of the four Slots. Set it up as follows:

1. Hold down the **SHIFT** button, and press the “**SPECIAL**” button repeatedly until the leftmost character in the **DISPLAY** shows ‘E’ (for “Expression Pedal”).
2. Select a Slot for which you want to set the pedal function by pressing one of the buttons **A** to **D**.

- If you want the connected pedal to duplicate the functionality of the MODULATION WHEEL, press the DOWN button until the DISPLAY reads 'E.oF'.



With this setting, the expression pedal will have the same function as the MODULATION WHEEL.

- If you instead want to select an independent control function for the pedal, press the STORE button. The DISPLAY will flash, showing one of the abbreviations in the table below.
- Use the UP/DOWN buttons to select one of the following control functions:

Display shows:	Pedal assigned to:
	LFO 1 Amount.
	LFO 2 Amount.
	Filter Cutoff Frequency.
	FM Amount.
	Oscillator 2 Pitch.

- After you have made your choice, press STORE again. You will return to the 'E' display.
- Use the UP/DOWN buttons to select a control amount value ('1' to '7'). This value (shown to the right in the DISPLAY) determines the range of the pedal control signal. Lower values give a smaller difference between the pedal's "full up" and "full down" states. High values give a greater difference between the pedal's up and down states.
- If needed, repeat steps 5 to 10 to set pedal control function for the other slots.
- Press SHIFT to exit the Special menu and return to play mode.

Nord Lead 2X will also recognize Expression pedal messages via MIDI as MIDI Controller #11.

THE "PANIC" BUTTON

If notes should "hang" or the Nord Lead 2X should behave strange, all you need to do is hold down the SHIFT button and press "Panic" (the DISTORTION button in the Filter section). This will execute an internal All Notes Off, and reset certain parameters to normal values.



The Panic button.

4. EDITING PROGRAMS

CHANGING AN EXISTING PROGRAM

Actually, how to change a programmed sound can be described in one sentence: “twist the knobs and press the buttons”. It *is* as simple as that!

- For information about editing Percussion Kits, refer to [page 29](#).
- Don't be afraid to edit and overwrite the RAM Programs in the internal memory (Program 1 - 3.99). If you want to restore any of the original RAM factory programs later on, they can be fetched as standard MIDI files at <http://www.clavia.se> and downloaded to the Nord Lead 2X from a MIDI sequencer.

CHANGING ONE PROGRAM IN A LAYER

If you have layered Programs you can still edit one of the Programs from the front panel. Proceed as follows:

1. Press the Slot button that you want to edit. Its LED will flash to indicate it is the *active Slot*.
2. Use the front panel knobs and buttons to change the Program in the active Slot.

REVERTING TO THE ORIGINAL PROGRAM

If you have edited a Program and want to get back to the programmed original, proceed as follows:

1. Select another Program for the Slot with the UP/DOWN buttons.
2. Select the first Program again. It will now have reverted back to the way it was when you last selected it.

USING MANUAL MODE



If you want to use the front panel to make up a sound from scratch, hold down **SHIFT** and press the Manual (**PERF. MODE**) button. This leaves you with exactly the sound that the knobs and buttons on the panel currently indicate (just as if the Nord Lead 2X was a non-programmable instrument). In Manual mode, the instrument can play only one sound - layering is not possible.

CUSTOMIZING MANUAL MODE

When you enter Manual mode, the button functions (waveform select, modulation destinations etc.) will be set to some default values, for a basic sound. However, if you would like Manual mode to be different the next time you turn on power, proceed as follows:

1. Enter Manual mode by holding down **SHIFT** and pressing the Manual (**PERF. MODE**) button.
2. Set all button functions as you want them.
3. Press **STORE** twice.

STORING PROGRAMS

Storing is done identically regardless if you are saving an edited Program or if you are saving from Manual mode.

Saving a Program will permanently overwrite an existing Program. Be careful so that you don't accidentally erase a Program you'd like to keep! However, if you want to restore any of the original RAM factory programs later on, they can be fetched as standard MIDI files at <http://www.clavia.se> and downloaded to the Nord Lead 2X from a MIDI sequencer

1. Press the **STORE** button. The **DISPLAY** flashes.
2. Use the **UP/DOWN** buttons to select a Program number. As you scroll through the memory locations, you can play and hear the Program currently shown in the **DISPLAY**. This prevents you from overwriting a sound that you want to keep. **Only Program numbers from 1-3.99 in internal memory can be overwritten. If you try to save in higher Program numbers, nothing will happen.**
3. If you change your mind at this point, press the Slot you want to return to or hold down **SHIFT** and press the Manual (**PERF. MODE**) button to return to Manual Mode.
4. If you decide to go ahead with overwriting the existing Program, press **STORE** again. The **DISPLAY** stops flashing to indicate the Program has been saved.

COPYING PROGRAMS

Copying Programs from one memory location to another is just a variation on Storing:

1. Select the Program you want to copy.
2. Press **STORE**.
3. Use the **UP/DOWN** buttons to select a new Program number. As you scroll through the memory locations, you can play and hear the Program currently shown in the **DISPLAY**. This prevents you from overwriting a sound that you want to keep. **Only Program numbers from 1-3.99 in internal memory can be overwritten. If you try to save in higher Program numbers, nothing will happen.**
4. Press **STORE** again.

5. PROGRAMMING VELOCITY SENSITIVITY

THE FILTER VELOCITY FUNCTION

Press this button to make the Filter Envelope Amount respond to velocity. The LED indicates that the Velocity function is activated.

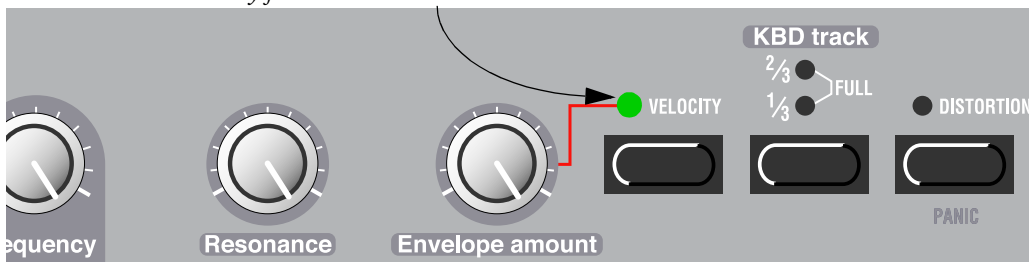

The quickest way to make a Program velocity sensitive, is to activate the Velocity function in the Filter section. This makes the Filter Envelope Amount vary with striking force, to a pre-determined degree. See [page 51](#) for details.

MAKING ANY PARAMETER VELOCITY DEPENDENT

You can make any continuous parameter (those controlled with knobs) react to velocity. You can also set the maximum and minimum boundaries for this, yourself.

SETTING THE PARAMETER RANGES

1. Set the parameter to the value you want it to deliver when you play with minimum force.
2. Press the VELOCITY/MORPH ASSIGN button. The LED over the button will flash, indicating that the Nord Lead 2X is in “Velocity Learn” mode.
3. Turn the knob to the value you want it to have at maximum striking force. You can try out different settings for maximum velocity until you find the most suitable. While the Nord Lead 2X is in “Velocity Learn” mode, you can set ranges for as many parameters as you wish. **Note that you could turn the knob in any direction - it doesn't necessarily have to be from a low value to a high.**
4. Press the VELOCITY/MORPH ASSIGN button again.

The VELOCITY/MORPH ASSIGN LED is now lit to indicate that at least one parameter in the sound is velocity dependant. What you have done now is to set the *range*, the span within which the parameter will change with velocity.

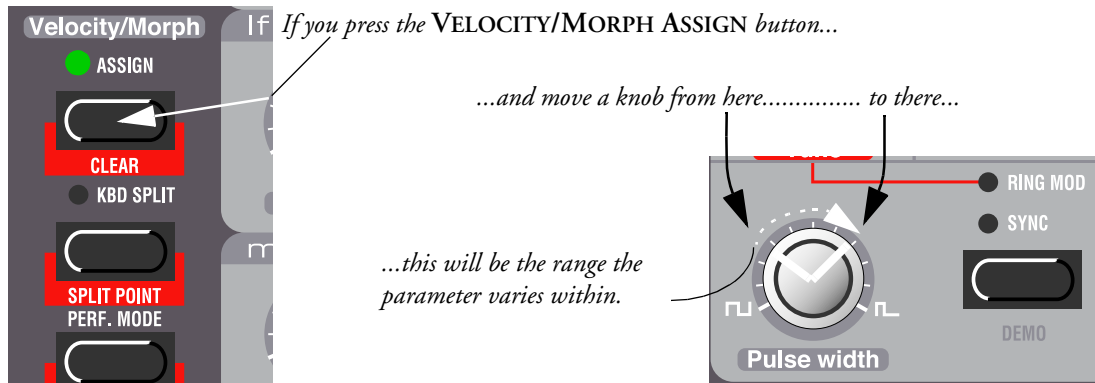

5. Turn the knob back to the value you want it to have when you play with minimum force. What you did now was moving the entire range, as described below.

Set the value you want the parameter to have when you play with minimum force.

If you have set the range as described in the previous picture, this will be the value you get when playing with maximum force.

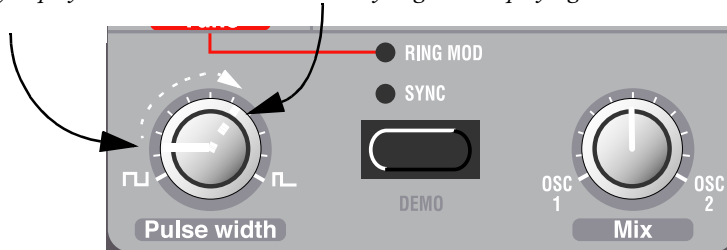

6. Play the Program to try out the effect.

Please note that any two values can be used when setting the range. To make a parameter value decrease when you play with more force, i.e. have “reversed” velocity response, simply use a low value for the “maximum force” setting and a higher value for the “minimum force” setting, when you are defining the range.

MOVING THE RANGE

As explained above, step 1 to 4 sets the range of the parameter, how far it should be between the minimum and maximum values.

If you then turn a knob that has been programmed for velocity sensitivity, without holding any buttons or anything, you will adjust the minimum value only and the maximum value will move with it, accordingly.

If you adjust the value for a parameter programmed for velocity control, you move the entire velocity control range up/down:

This minimum value will result in this maximum value.

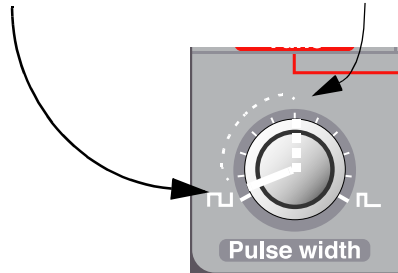

This minimum value will result in this maximum value.

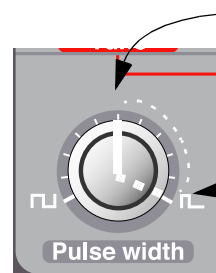

CLEARING VELOCITY PROGRAMMING FOR ONE KNOB

1. Turn the knob to its lowest value.
2. Press the VELOCITY/MORPH ASSIGN button.
3. Turn the knob a bit up and then back to its lowest value.
4. Press the VELOCITY/MORPH ASSIGN button again. The Velocity/Morph function is now cleared for the knob.
5. Turn the knob back up to any desired value. When velocity programming is cleared for all knobs, the VELOCITY/MORPH ASSIGN LED goes out.

CLEARING ALL VELOCITY PROGRAMMING

To clear all velocity programming, hold down SHIFT and press the VELOCITY/MORPH ASSIGN button.

MORPHING

Morphing is a term used to describe a continuous “transfer” between two images, sounds or similar. As described above, the Velocity/Morph function in Nord Lead 2X is normally controlled by velocity. But you can route the function to the MOD WHEEL instead which allows you to continuously fade between two sounds – morphing!

The only thing you have to do to activate morphing for a sound that’s already set up for velocity control is to press the Mod Wheel destination button until Morph is the only lit indicator:

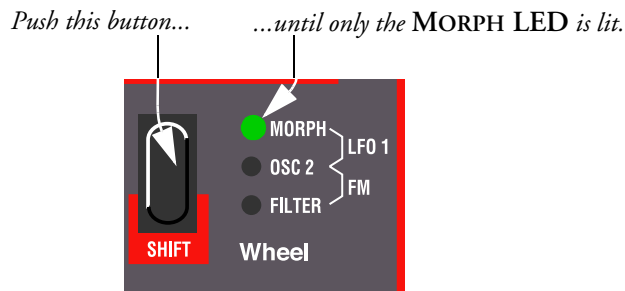

However, if you are setting up a Morph sound from scratch, we recommend the following procedure:

1. Press the MOD WHEEL DESTINATION (SHIFT) button until only the MORPH LED is lit.
2. Make sure the MOD WHEEL is all the way down.
3. Set up the Program (sound) as you want it.
4. Move the MOD WHEEL all the way up.
5. Press the VELOCITY/MORPH ASSIGN button and adjust the knobs so that the Program sounds the way you want it at “the other end” of the Morph.
6. Press the VELOCITY/MORPH ASSIGN button again.
7. Play and move the MOD WHEEL to try out the effect.

You can also use an Expression pedal for Morphing, see [page 19](#).

Please note that the Velocity function in the Filter section can be used even if Morphing is active, so that a Program can be basically Velocity sensitive even though Morphing is activated.

6. PERCUSSION KITS

The Nord Lead 2X Percussion Kits consist of eight different virtual analog percussion sounds, arranged in zones across the keyboard. They allow you to incorporate percussion patterns in your music without using up more than one Nord Lead 2X Program Slot.

SELECTING AND PLAYING A PERCUSSION KIT

1. Select the Slot where you want the Percussion Kit. You can select Percussion Kits for all four slots if you like, giving you a total of 32 different percussion sounds available simultaneously.
2. Use the UP/DOWN buttons to scroll past Program number 99 (in Banks 0-3) and select one of the Percussion Kits 'P0-P9'. There are 4x10 rewritable Percussion Kits (P0-P9, 1.P0-1.P9, 2.P0-2.P9 and 3.P0-3.P9). The Percussion Kits are located directly after the "regular" Programs and labelled 'P0' to 'P9'. For example, select Percussion Kit P0.

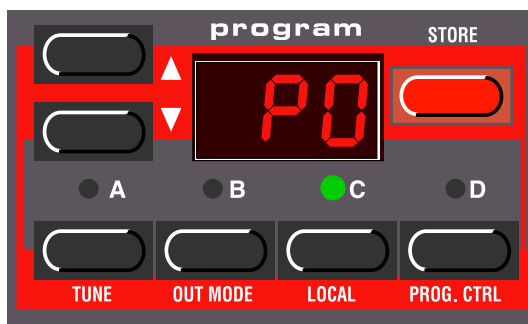

Percussion Kit P0 selected in Program Slot C.

3. Use the white keys to play the percussion sounds in the selected Kit. There are eight different sound zones in each Percussion Kit, arranged across the keyboard like this:

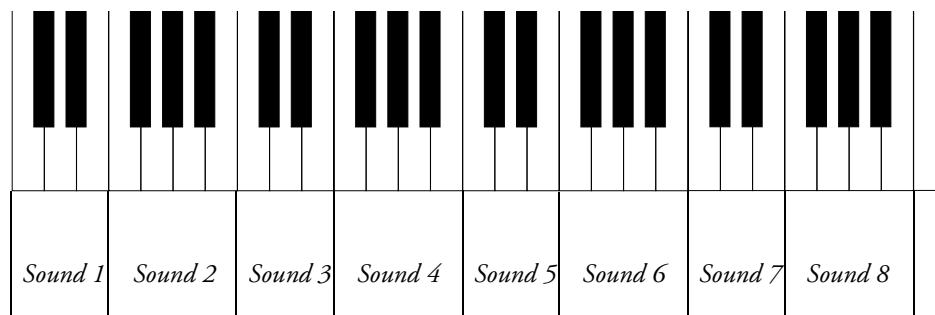

If you for example press the lowest keys F, G, A or B with Percussion Kit P0 selected, you will play a snare sound. The names of the Percussion Kits are listed on [page 96](#). The keys in a zone will produce different pitches, just as if you played the sound as a regular Program. However, some percussion sounds are not programmed to respond to keyboard pitch.

EDITING THE SOUNDS IN A PERCUSSION KIT

While the white keys are used to play the percussion sounds, the black keys are used for selecting which sound to edit:

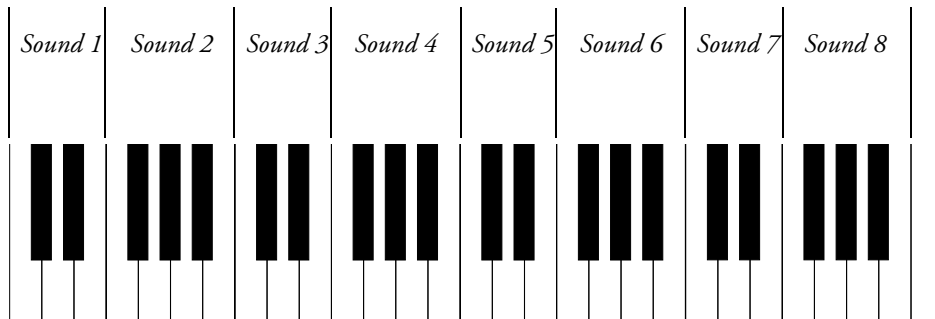

If for example you want to edit the snare sound in kit P0, proceed as follows:

1. Select Percussion Kit P0 as described on the previous page.
2. Press one of the keys F#, G#, A# in the lowest octave. The DISPLAY will briefly show '-2', indicating that sound zone number 2 is selected for editing.

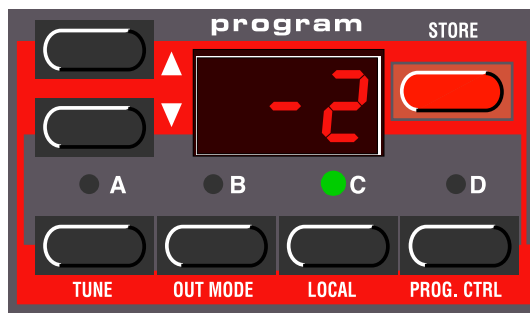

3. Now you can use the knobs and buttons on the panel to edit the selected percussion sound to your liking, just as in regular Nord Lead 2X programs. You can play the other sounds freely while editing the selected sound, as long as you don't press any other black key (since this would select another sound for editing). There is one limitation when programming the percussion sounds: All of the sounds in a Percussion Kit will share the same LFOs. The Nord Lead 2X will use the LFO rate, waveform and destination settings of the last played percussion sound.
4. When you're satisfied with the first sound, press another black key to select another percussion sound for editing, according to the figure above.

SAVING PERCUSSION KITS

1. After editing the percussion sounds, press STORE. The DISPLAY flashes.
2. Use the UP/DOWN buttons to select a Percussion Kit location in any of the first four Percussion Kit banks.
3. Press STORE. The edited Percussion Kit is saved to the selected location.

COPYING, EXTRACTING AND IMPORTING INDIVIDUAL PERCUSSION SOUNDS

You can easily copy a percussion sound for use in another zone. This zone can be in the same Percussion Kit or in another one. You can also “extract” the percussion sound and save it as a regular Program.

1. Locate the zone of the percussion sound you want to copy/extract. Hold down a black key in this zone and press STORE. The DISPLAY flashes.
2. Scroll to the Program or Percussion Kit location to which you want to copy the percussion sound.
3. If you have selected a regular Program to save the sound in, just press STORE again.
4. If you want to save the sound in a zone in a Percussion Kit, hold down a black key in the destination zone and press STORE.

You may also want to “import” a sound that is currently a regular Program, and use it as a part of a Percussion Kit. Proceed as follows:

1. Select the Program and press STORE.
2. Scroll to the Percussion Kit location to which you want to copy the sound.
3. Hold down a black key in the zone to which you want to copy the sound, and press STORE again.

SYSEX DUMPS OF PERCUSSION KITS

You can transmit and receive SysEx data that contains all settings for a single Percussion Kit, just as for a regular Program. However, there are a couple of things to note:

- You’ve got to initiate the dump from Program Mode, not from Performance mode! If you make a SysEx dump from Performance mode, the actual parameters of the Percussion Kit will not be included in the dump, only a reference to which Percussion Kit is used in the Performance.
- Before receiving a Percussion Kit SysEx data dump, you must select a Percussion Kit for the “receiving” Slot. If you attempt to receive a Percussion Kit into a Slot which plays a regular Program, nothing will happen. Likewise, you cannot receive regular Program SysEx data into a Slot which currently plays a Percussion Kit.

USING PERCUSSION KITS IN PERFORMANCE MODE

In Performance mode, there is one big difference between regular Programs and Percussion Kits:

A Percussion Kit in a Performance is only a reference to the original Percussion Kit memory location!

Any changes you make to a Percussion Kit in Performance mode, will not be included when you save the Performance. If you want to edit your Percussion Kit for use in a Performance, there are two ways of doing this:

- Edit and store your Percussion Kit in Program mode (you might want to save it on another location, to preserve the original, unedited Kit). Then go to Performance mode and select your edited Percussion Kit for one of the Slots.
- Edit the Percussion Kit in Performance Mode. Then, for each edited Percussion sound in the Kit, select the sound by pressing a black key in that zone and press **STORE** twice. Note however, that this will change the original Percussion Kit, and all Performances that use this Percussion Kit will be affected by the changes!

7. PERFORMANCES

WHAT IS A PERFORMANCE?

Performances allow you to call up four Programs at a time in a live situation, or to recall complete setups when sequencing via MIDI. The Nord Lead 2X comes with 100 rewritable Performances and another 3x100 Performances in ROM. Some of these make use of two, three or four Slots, while some are single-Slot Performances, effectively serving as extra “Programs”. Please note:

- You can edit selected ROM Performance as desired, but you can only save your changes in the first Performance bank (A.0-L.9).
- You can transmit edited Performance data via MIDI SysEx, for storage in an external sequencer, etc.
- If the Performance contains a Percussion Kit, only the *reference* to the Kit Location will be saved with the SysEx dump! To include the parameters for the Percussion Kit, you need to make a separate SysEx dump of the Percussion Kit, from Program mode (not from Performance mode).
- You can receive SysEx data for one Performance at a time into the edit buffer. If you for example use Nord Lead 2X multitimbrally together with a sequencer, it is often practical to place a SysEx Performance data dump in the beginning of your song, to select sounds, initialize global settings, etc.

The Factory Performances include several life-like drawbar organ simulations, created using a special “pseudo-additive” synthesis method. Some of the sounds include famous sound artifacts such as “hum” and “click” as well as rotating speaker effects, accomplished with the Nord Lead2X’s Morph function. Among the Performances you can also find recreations of over 40 original factory patches from the classic vintage synthesizer Prophet 5. All Performances are listed on [page 97](#).

Later in this text follows a detailed list of what settings are contained in a Performance.

RECALLING A PERFORMANCE

When you recall a Performance, you replace the four current sounds in the slots A to D with the sounds in the recalled Performance. You also recall other settings as listed in the table later in this chapter.

1. Enter Performance mode by pressing the **PERF. MODE** button. The **DISPLAY** shows the latest selected Performance.

The Performances are organised in 4 Banks, each holding 100 Performances. The Performances are named alphabetically from A0-L9 in each Bank (the letters I and K are excluded because they’re hard to show clearly in the **DISPLAY**). The Performances in the first Bank there are rewritable and the rest are in ROM.

- To select a Performance, use the UP/DOWN buttons. (If you want to select Performances in steps of ten, hold down SHIFT and press the UP/DOWN buttons.) The Performance is instantly loaded and you can try it out.

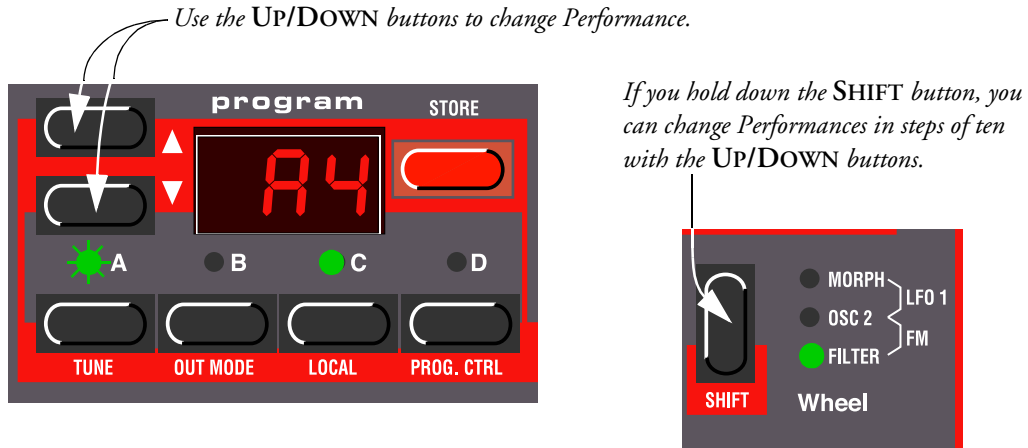

You can also select Performances via MIDI, see [page 75](#).

Please note that selecting a new Performance changes a lot of parameters, including MIDI Channels and Special modes for each Program slot. This might lead to silent sounds!

EDITING A PERFORMANCE

SELECTING PROGRAMS AS BASE FOR A PERFORMANCE

To replace a sound in a Performance, proceed as follows:

- Hold down the desired Slot button (A to D). The DISPLAYS shows which Program was used for this Slot, when the Performance was created. Note that you *copy* the Program to the Performance. This means that you're free to edit and change the original Program (in Program mode) afterwards without affecting the Performance.

2. While holding down the SLOT button, select a Program for the Slot, just as you would in Program mode. See [page 12](#).

Hold down the desired Slot button (its LED will blink, and the DISPLAY will show the selected Program for the slot).

Use the UP/DOWN buttons to select another program for the Slot in the Performance.

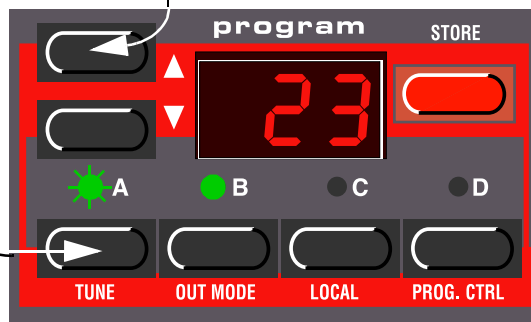

LAYERING AND EDITING

This is done just as in Program mode. The only thing to note is that when you save the Performance you save the edited Program(s) “within” the Performance. The original Program that you used as a basis for the Performance is not affected.

This is not true for Percussion Kits, which are only referenced in the Performances. **Any editing done to a Percussion Kit in Performance mode will affect the “original” Percussion Kit, and all references to it in other Performances.**

SHIFT FUNCTIONS

Again, these parameters are set just as in Program mode. Most of these parameters are also saved with the Performance as indicated in the table on the next page.

SAVING A PERFORMANCE

To be able to save edited Performances, you have to save it to any of the first 100 Performance memory locations (A.0-L.9).

1. Edit the Performance as desired.
2. Press the STORE button. The DISPLAY flashes.
3. Select one of the first 100 Performance memory locations, as described above.
4. If you change your mind at this point, press any of the SLOT buttons to abort.
5. If you decide to go ahead with overwriting the existing Performance, press STORE again. The DISPLAY stops flashing to indicate that the Performance has been saved.

Programs in Performance Slots are actually saved complete with all parameter settings when the Performance is saved. Percussion Kits, on the other hand, are only saved as references to existing Percussion Kits.

The above point means that there is no need to store the *Programs* separately. As soon as you save the Performance, all Programs that it uses are also saved, inside the Performance. This also means that if you later change any of your Programs, from Program mode, the Programs in the Performances are not affected in any way.

On the other hand, *Percussion Kits* need to be saved separately, as described on [page 31](#).

EXTRACTING SINGLE SOUNDS FROM A PERFORMANCE

The text below does not apply to Percussion Kits in Performances.

As stated earlier, the sounds used in the Slots of a Performance are *not* references to regular, existing Programs, but complete Program patches “in their own right”. You will find several unique sounds in the factory Performances, sounds that you will not find in any of the internal Program locations. You may want to extract such a sound, for use as a single Program, or to make it part of another Performance. Proceed as follows:

1. Select the Performance containing the sound you want to extract.
2. Make sure the Slot with the desired sound is selected (LED is flashing).
3. Press STORE.
4. Press the PERF. MODE button, to exit Performance mode.
5. Scroll to a suitable Program location (1- 3.99) in the internal memory and press STORE again. The sound is stored as a regular Program. This can now be played as usual, or included in another Performance as described on the previous page.

EXITING PERFORMANCE MODE

To exit Performance mode, press the PERF. MODE button. Now, you return to the regular Program mode. You will note that the four slots now play the four Programs that were selected *before* you entered Performance mode. Likewise, Layering and Shift functions are restored to the way they were set before you entered Performance mode.

WHAT A PERFORMANCE CONTAINS

The following is a list of what a Performance contains, that is, what you actually save and recall when you work with Performances:

FOR EACH PROGRAM SLOT

- The selected Program complete with parameter settings *or* a reference to a Percussion Kit.
- The MIDI Channel setting
- The 'Special' settings
- Expression pedal assignment
- Aftertouch assignment

FOR THE ENTIRE PERFORMANCE

- The Layer configuration
- The Keyboard Split settings
- Which Program is active for editing
- The Pitch Bend Range setting
- The Out Mode setting
- The Unison Detune setting

8. PANEL REFERENCE

OSCILLATOR 1

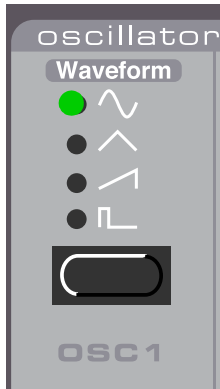

WAVEFORM SELECTOR

Select one of four basic waveforms for Oscillator 1 with the **WAVEFORM SELECTOR** button:

SINE

The sine wave is the simplest waveform there is. It has no additional harmonics. It is suitable for very soft sounds or for use with FM.

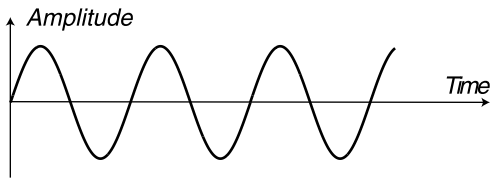

The pure sine wave with no additional harmonics

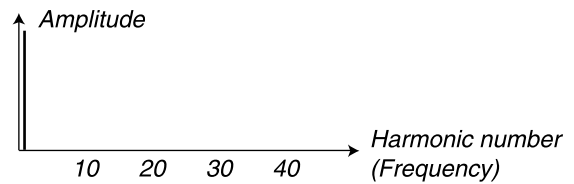

The frequency "spectrum" of a sine wave: only the fundamental frequency is present

TRIANGLE

The triangle waveform has only odd and not very strong harmonics. It is suitable for flute sounds and similar.

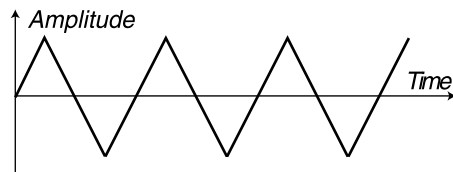

The triangle wave

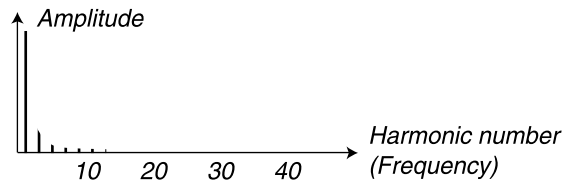

The frequency spectrum of the triangle wave contains only odd harmonics at fairly low levels

SAWTOOTH

The sawtooth wave contains all harmonics and is the richest of the available waveforms. It is suitable for all sorts of sounds.

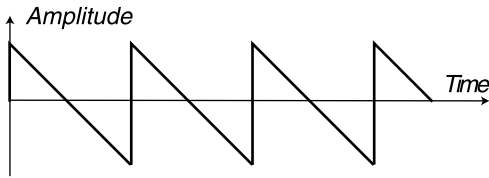

The sawtooth signal shape

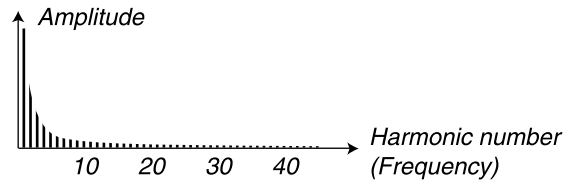

The sawtooth signal frequency spectrum

PULSE

The pulse wave contains only odd harmonics at 50% pulse width (square wave). This waveform is special in that its harmonic content can be varied continuously, by adjusting the Pulse Width with the PULSE WIDTH knob. The pulse wave can also be modulated by LFO 1 and the Modulation Envelope. This waveform is suitable for many type of sounds and has a more “hollow” character than the Sawtooth wave.

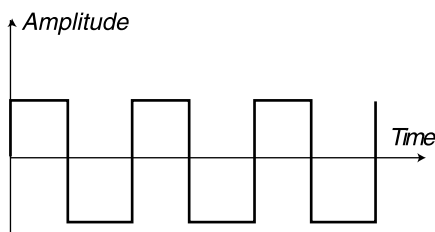

The pure square wave: a pulse wave with 50% pulse width

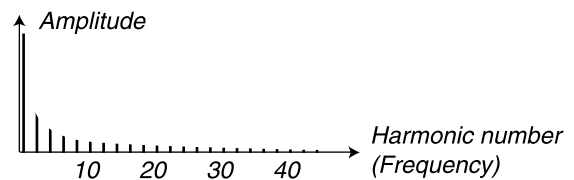

The frequency spectrum of a pure square wave. The signal contains only odd harmonics

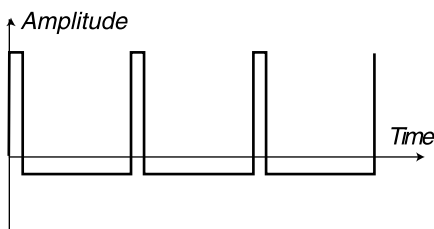

The pulse wave at 10% pulse width

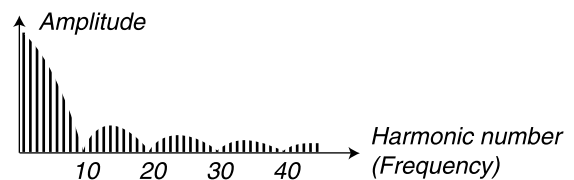

The frequency spectrum at 10% pulse width. Now, also even harmonics are gradually introduced making the sound “sharper” but also “thinner”

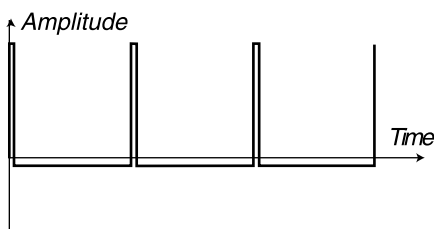

The pulse wave at 5% pulse width

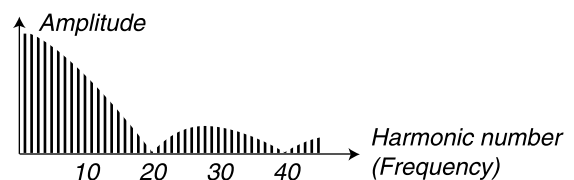

The narrower the pulse width, the more harmonics are present in the frequency spectrum

For a theoretical introduction to waveforms, see [page 80](#).

OSCILLATOR 2



WAVEFORM SELECTOR

The first three waveform alternatives for Oscillator 2 are identical to the corresponding waveforms of Oscillator 1 (see above). Oscillator 2 also has another waveform, the Noise:

NOISE, NOISE COLOUR AND SYNC WAVE

With Noise selected, Oscillator 2 produces noise rather than a pitched waveform. The exact color (frequency content) of the noise can be adjusted with the Oscillator 2 SEMITONES knob. The further you turn the knob clockwise, the brighter the noise. All the way to the right, its frequency characteristics is very close to that of white noise (where all frequencies are represented with equal energy).

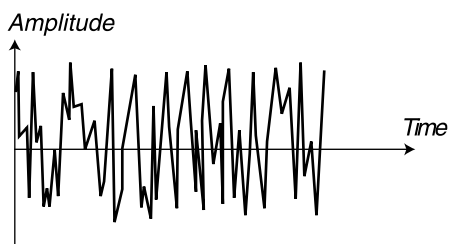

'White noise' contains all frequencies at equal energy levels



Note that the sound of the noise is also affected by the filter setting (as all other sound from the Nord Lead 2X). If the filter frequency is turned down, adjusting Noise color might not have the expected effect.

If Sync is activated (see [page 43](#)), selecting Noise will produce very special signals with non-transposed formant spectrum with strong “body resonance” characteristics. The reason ‘synced noise’ works at all is that it’s the same series of frequencies that are synced (repeated over and over). In a traditional analog system this function wouldn’t work since the noise is totally random. In ‘Sync wave’ mode the SEMITONES knob works as a “waveform selector”. Turning the knob will change the harmonic content of the sound. The Sync wave selection is not continuous, but stepped, in steps that correspond to the octave

markings around the SEMITONES knob. It can be controlled by the Velocity/morph function, but is not affected by LFO 1, the Modulation Envelope or the Modulation Wheel, even when these have Oscillator 2 selected as modulation destination.

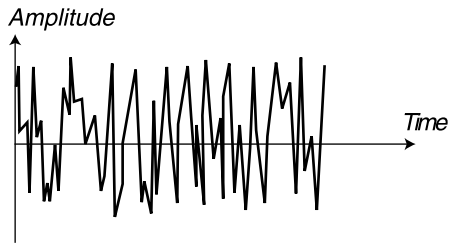

Non-synched white noise contains all frequencies at equal levels.

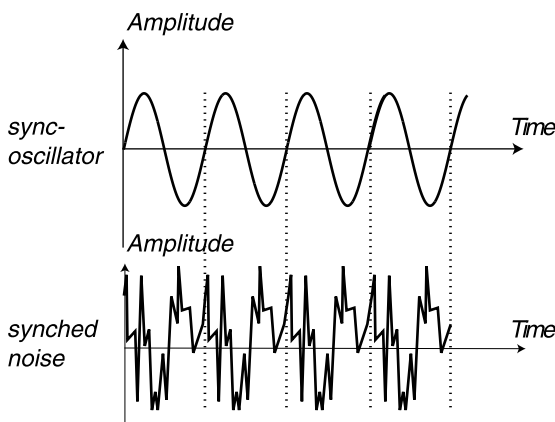

The synched noise repeats itself each time the sync oscillator starts a new period

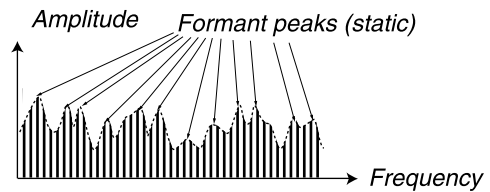

Synched noise produces a special type of digital waveforms with static "body resonance" characteristics

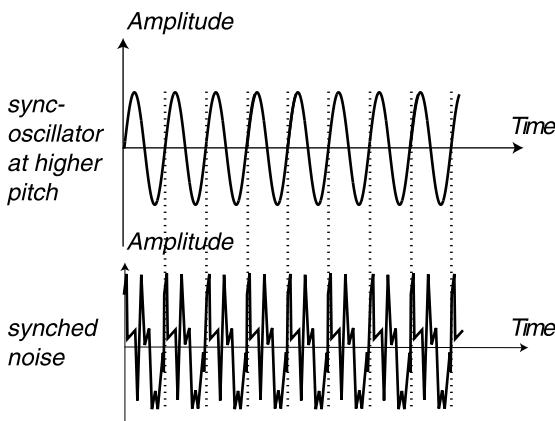

Here, the noise signal is the same as before, only now the sync oscillator has higher pitch

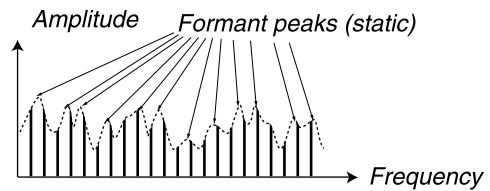

Synched noise at higher pitch. As you can see, the formant peaks are the same even though the pitch is higher

SEMITONES

This setting is used to adjust the tuning of Oscillator 2, relative to Oscillator 1. The setting is in semitone steps. The range is from 5 octaves below Oscillator 1, to 5 octaves above Oscillator 1. However, the full range may not be available, depending on the Oct Shift setting (see [page 61](#)). To aid you in setting the value, the LED above the knob lights up when the tuning is in perfect octaves.

FINE TUNE

This parameter is for tuning Oscillator 2, just as the SEMITONES KNOB is. The difference is that this parameter operates *within* one semitone. If you set the two oscillators to equal volume (see Mix below), make sure Sync and Ring Mod is turned off, set the Oscillator 2 Semitones value to '0' and turn the FINE TUNE knob slightly, the slight difference in pitch will make the sound "richer". The LED above the Semitone knob will flash briefly when you set FINE TUNE to 0.

KBD TRACK

When this parameter is *activated*, Oscillator 2 will have different pitches when you play different keys, just as Oscillator 1 always does. When this parameter is turned *off*, Oscillator 2 will always play the same pitch. There are mainly three situations when this is useful:

- When Sync is activated (in this mode, the basic pitch of the sound is determined by Oscillator 1 anyway).
- When FM or Ring Modulation are used, to get inharmonic sounds with very varying timbre across the keyboard.
- For special effects and percussion sounds, which are supposed to sound the same all across the keyboard.

SETTINGS FOR BOTH OSCILLATORS

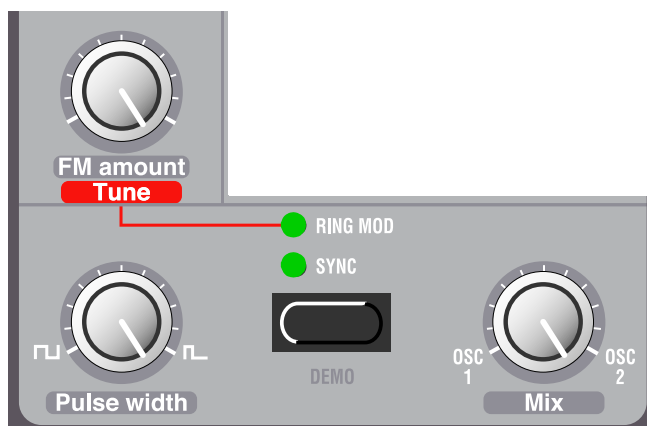

FM AMOUNT

This is classic "deep linear FM". The FM function is a bit of depart from the "analog" concept of the Nord Lead 2X, but as you will find, it is a very useful addition. When using FM, Oscillator 2 frequency modulates Oscillator 1. In FM speak, Oscillator 1 is the Carrier and Oscillator 2 is the Modulator. This

means that changing the pitch of Oscillator 2 basically does not affect the pitch of the sound, but the timbre. The FM AMOUNT knob controls the amount of FM from Oscillator 2 to Oscillator 1.

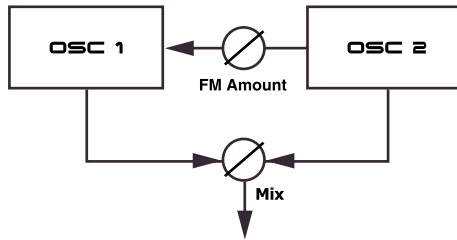

For classic FM sounds, use sine wave on oscillator 1 and triangle wave on oscillator 2.

MODULATION OF FM AMOUNT

Please note that the amount of FM can be modulated from the Mod Env and LFO 1, and also controlled manually from the MOD WHEEL.

RING MOD

Activate Ring Modulation by pressing the RING MOD/SYNC button until the RING MOD LED is lit. This is a function (also known as amplitude modulation), where the waveforms of the two oscillators are multiplied. The result is an inharmonic sound, that is great for metallic or bell-like timbres.

When trying out Ring Modulation, make sure you listen to Oscillator 2, since it is mainly this that is affected by the timbre changes!

Turning the Oscillator 2 SEMITONES knob will change the timbre, much as with FM. However, with Ring Modulation, this will *also* affect the pitch of the sound! This means that activating Ring Modulation may result in a sound with a completely different pitch than the “normal” sounds. To remedy this, you should use the Ring Mod TUNE knob:



When Ring Modulation is activated, the FM Amount knob works as a Tune knob with a range of roughly one octave. To set the pitch to “normal”, turn off Ring Modulation and play a note, then activate Ring Modulation, play the same note and adjust the Tune knob until the pitch is the same. Please note that the pitch will change again if you change the timbre by adjusting the Semitones knob.

When Ring Modulation is activated, you cannot manually control the FM Amount, since that knob serves as a Tune knob. Instead you can use the Modulation Wheel, with its destination set to FM.

SYNC

Activate Oscillator Sync by pressing the **RING MOD/SYNC** button until the Sync LED is lit. In this mode, Oscillator 2 is “synched” to Oscillator 1. This means that each time a period in Oscillator 1’s waveform starts, Oscillator 2 is forced to start over with a new period, as well.

Example: a sawtooth wave synched by a sync oscillator. The sawtooth wave is restarted every time the sync oscillator begins a new cycle. The resulting signal gets deep resonance in its harmonics.

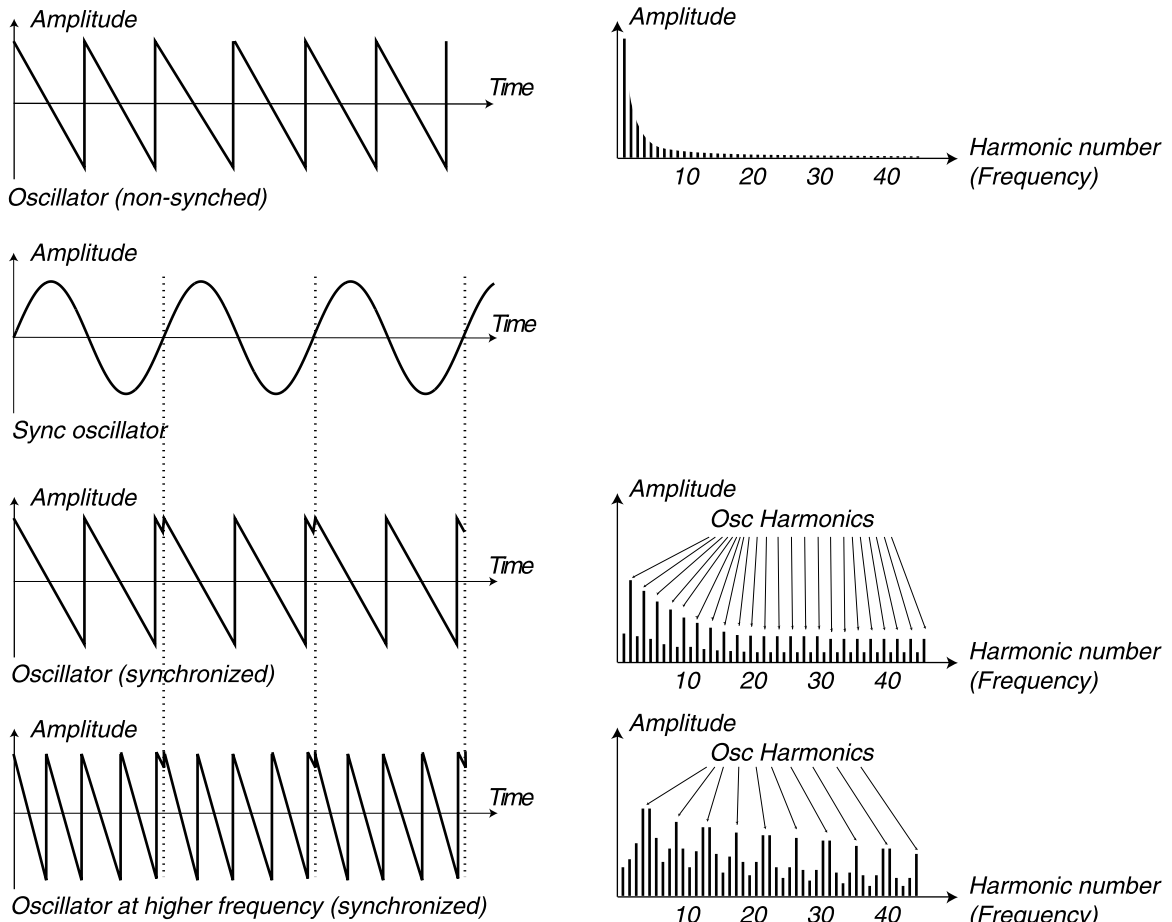

The effect of this is that if Oscillator 2’s pitch is higher than Oscillator 1, its resulting waveform will have a pitch determined by Oscillator 1, but a timbre depending on the pitch of Oscillator 2. See [page 84](#) for a more details.

The easiest way to try this out is probably to activate Sync, and adjust the **SEMITONE** knob for Oscillator 2 while holding down a note. When trying out Sync, make sure you listen to Oscillator 2, since this is the one affected by the changes!

MODULATION OF OSCILLATOR 2 PITCH

Please note you can modulate the pitch of Oscillator 2 in various ways: from LFO 1, the Mod Env and from the **MOD WHEEL**, for example. This can be used to create harmonically varying timbres with a very characteristic sound. Sync and Ring Modulation can be activated at the same time. Just press the **RING MOD/SYNC** button until both indicators are lit (see “[Ring Mod](#)” on [page 42](#)).

PULSE WIDTH

This function only has any effect if Pulse wave is selected for any of the oscillators (or both). It adjusts the pulse width of the Pulse waves. There's only one Pulse Width setting, and it is common for both oscillators.

- When you turn the knob all the way to the left you get a perfect square wave which has a characteristic “hollow” quality.
- When you turn the knob clockwise, the sounds gets progressively thinner. See [page 83](#) for a general introduction to pulse waves and pulse widths.

PULSE WIDTH MODULATION

Please note that the Pulse Width can be modulated by LFO 1 and the Modulation Envelope. This creates a sweeping “chorus-like” effect suitable for pads and string sounds.

MIX

Set the balance between Oscillator1 and 2 in the mix with the MIX knob.

AMPLIFIER



An amplifier is most often used at the final stage of a synth signal chain, to control volume. By modulating the amplifier with an envelope, the sound can be given its basic “shape”. In fact, the “volume shape” is one of the most important factors to how we identify the sound. By setting up a proper volume envelope you can make a sound “soft”, “hard”, “plucked” “static” etc.

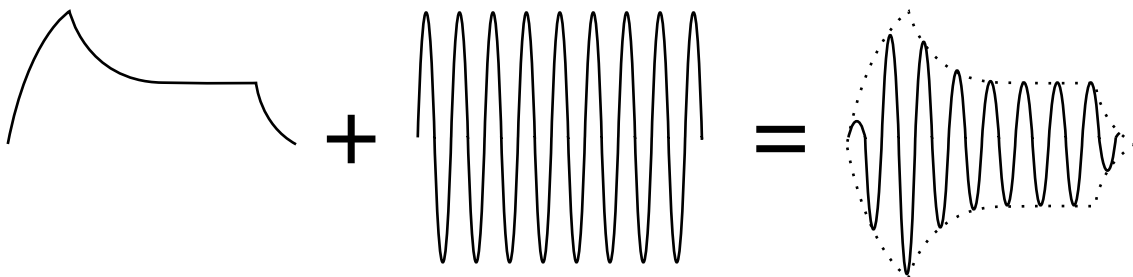

The volume envelope curve (to the left) determines how the amplitude of the waveform changes over time.

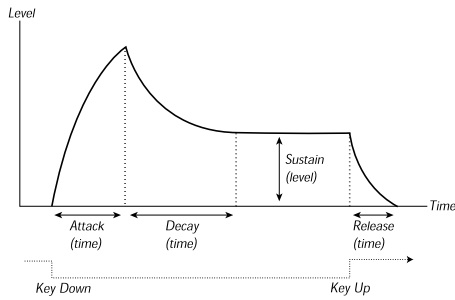

ATTACK

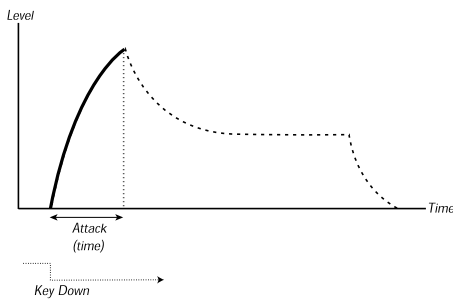

This control is used to adjust how long it should take for the sound to reach full volume after a key has been pressed. If the knob is turned fully counter-clockwise, the Attack is almost instantaneous. If the knob is turned all the way to the right, it lasts many seconds. **Note: a very short attack time could produce a click in the beginning of the sound. This is a normal physical phenomenon. To eliminate any click, just increase the attack time slightly.**

DECAY

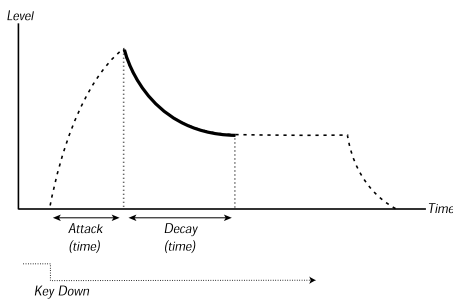

After the attack phase is finished (and you haven't released the key), the Decay begins. During the Decay phase, the sound decreases in level, and continues to do so until it reaches the Sustain level (see below). The Decay knob is used to adjust how long this should take.

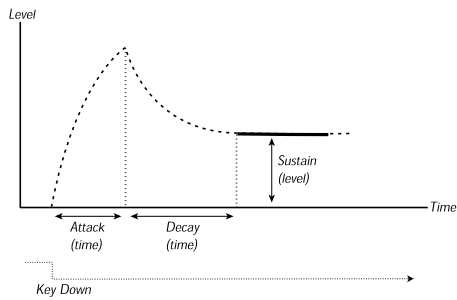
SUSTAIN

This is the level the sound will reach after the Decay phase. Once this has happened, the sound will stay steady at this volume until the key is released. Please note that the Sustain parameter is used to set a *level*, while Attack, Decay and Release all are used to set *times*.

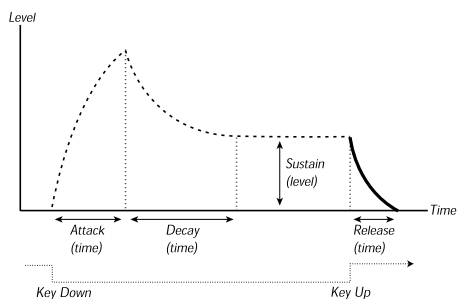
RELEASE

This knob is used to adjust how long time it should take for the sound to decay to silence *after* you have released the key. **Note:** a very short release time could produce a click in the end of the sound (when you release the key(s)). This is a normal physical phenomenon. To eliminate any click, just increase the release time slightly.

ADSR ENVELOPE BEHAVIOR

If you set the Sustain to full level, the Decay setting is of no importance since the volume of the sound is never lowered (until you release the key).

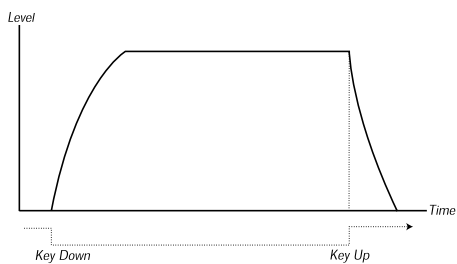

If you set the Sustain to 0, the sound will become silent after the Decay phase is finished. With short Attacks and moderate Decay times, this can be used to simulate the behaviour of a plucked string instrument (guitar, piano etc.) where the sound always decays to silence after a while.

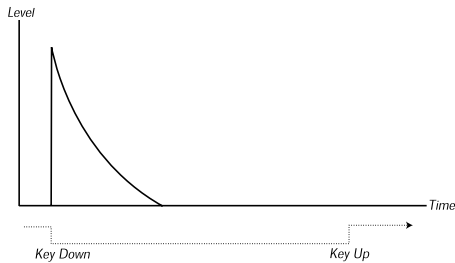

If a key is released before the envelope has completed one or more stages, the envelope will jump directly to the Release stage at the corresponding level.

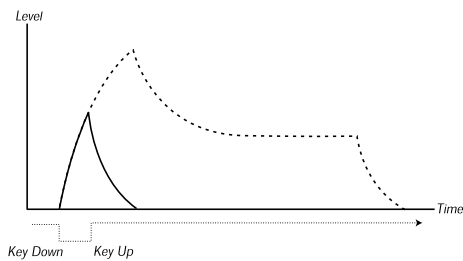

GAIN

This is used to adjust the overall Level of the Sound. This parameter is mainly used to balance one Program against another. The Gain parameter sends and responds to MIDI CC#7 (Volume).

FILTER



The Filter is the most important section for shaping the overall timbre of the sound. Nord Lead 2X's filter can be switched between various *types*. It has the standard main Frequency and Resonance controls. The Attack, Decay, Sustain and Release parameters make up the Filter Envelope. These, together with the En-

velope Amount knob, can be used to make the Filter frequency vary as the sound progresses, when you press and hold a key. For a theoretical introduction to filters, see [page 85](#).

FILTER TYPE

LP 12dB

LP stands for low-pass. A low-pass filter lets low frequencies pass and cuts out higher frequencies. Exactly which frequencies get cut out is determined by the Filter Frequency setting (and various other controls, as described below).

In the 12dB low-pass mode, the filter has a gentle roll-off curve (12dB=2poles). This mode leaves more harmonics than the 24dB variation discussed below. This type of filter has been used in various Oberheim synthesizers and others.

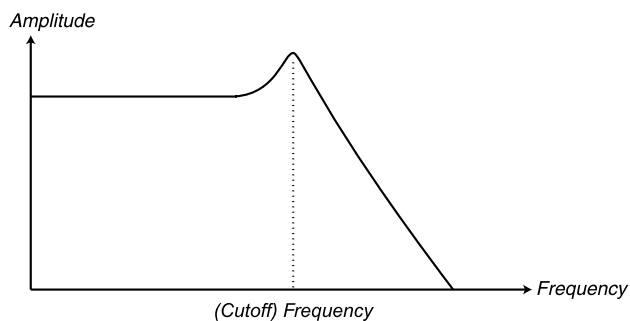

LP 24 dB

This is the classic synth filter used in the Minimoog and Prophet-5, among others. It cuts out high frequencies rather drastically (24db=4 poles).

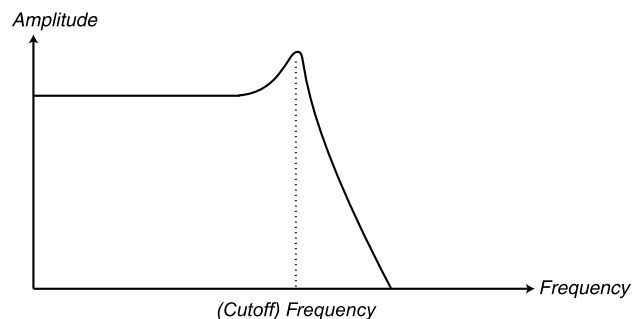

HP 24dB

HP stands for high-pass. This filter is the opposite of the lowpass filter, that is it lets the high frequencies pass and cuts out low frequencies. The filter has a rather steep curve.

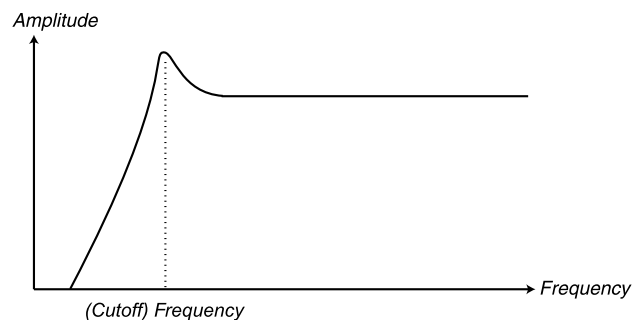

BP

To select this type of filter, press the Filter Type button until both the HP and LP 24 buttons light up. BP stands for band pass. In this mode the filter let's frequencies in the “mid-range” band pass through, while lower and higher frequencies are cut out. Each “slope” in this filter has a 12dB (2-pole) roll-off.

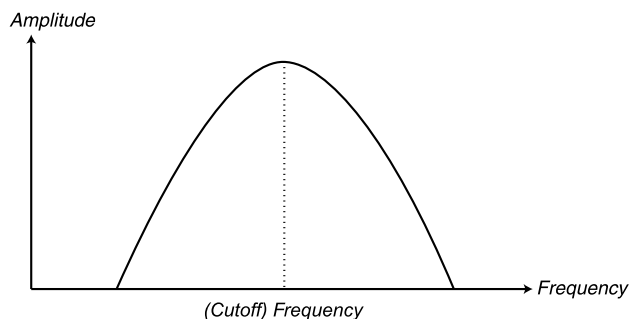
**NOTCH+LP**

To select this type of filter, press the Filter Type button until both the LP 12 and LP 24 buttons light up. A notch (or band reject) filter can be seen as the opposite of a band pass filter. It cuts off frequencies in a “mid-range” band, letting the frequencies below and above through. However, a plain notch filter is not very musically useful, since it often lets too many frequencies through, resulting in a very sharp, harsh sound. Therefore, the notch filter in Nord Lead 2X is combined with a 12dB Lowpass filter, resulting in a filter curve that looks like this:

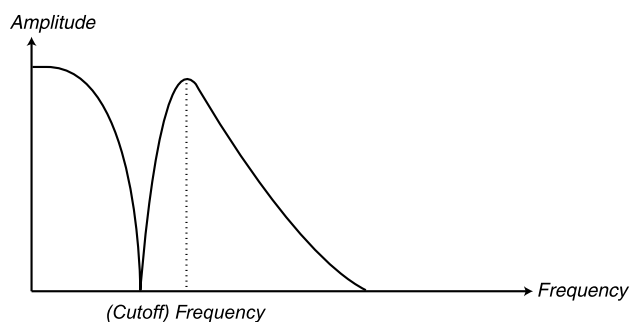

The audible result of this filter combination is a sound with plenty of body, some of the upper mid-range “bite” removed but a certain amount of high frequencies still present. This type of sound could be very useful for soft, yet clear pads, etc. The special characteristics of the Notch+LP filter will be most obvious with low Resonance settings.

FREQUENCY

This is the overall control for which part of the frequency spectrum the filter should operate in.

If you for example select a low pass filter and turn the Frequency knob clock-wise, more and more high-frequency material will be allowed to pass through the filter.

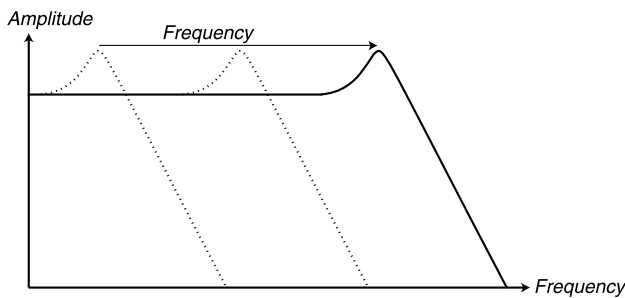

The more you “open” a low-pass filter, the more high-frequent the output signal

Please note that if the Envelope Amount setting is raised from its full left position, turning the Frequency knob might not change the sound as expected. For more information, see below.

RESONANCE

This control is used to emphasize the amplitude of the frequencies at, and close to, the cutoff frequency. If you are using a low pass filter, increasing resonance will emphasize frequencies around the set Filter Frequency and de-emphasize the rest of the frequency spectrum, making the sound thinner. Further raising the **RESONANCE** knob will make the sound resonant to a point where the filter adds a ringing quality to the sound. Exactly where in the frequency spectrum this “ringing” appears, depends on the Filter Frequency setting.

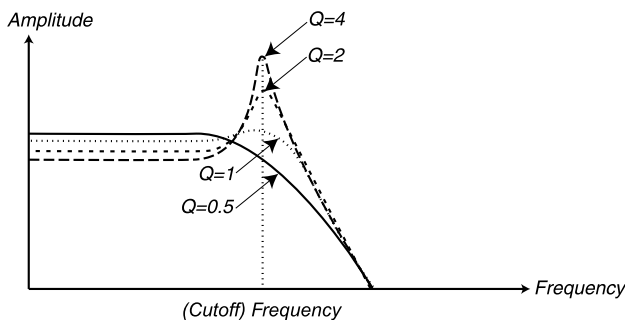

The figure shows a 24 dB lowpass filter with different resonance amounts (Q-values). Q=0.5 represents zero Resonance amount and Q=4 maximum amount.

If you have the high-pass or LP+Notch filter selected, increasing Resonance will work pretty much as with the LP filter.

When you use the band-pass filter, adjusting the Resonance also adjusts the width of the pass-band. When you raise the Resonance, the band where frequencies are let through, will become narrower.

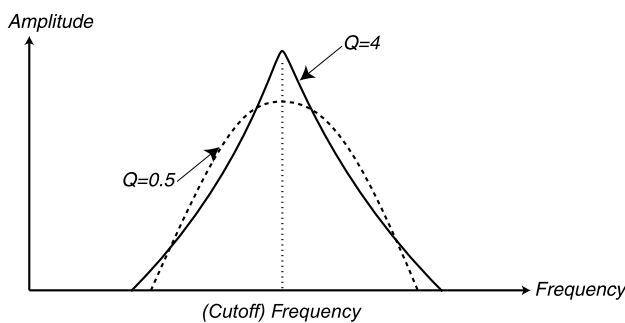

The figure shows a band-pass filter with different resonance amounts (Q-values). Q=0.5 represents zero Resonance amount and Q=4 maximum amount.

ENVELOPE AMOUNT

This is used to set to what degree the Envelope (see below) should affect the filter. The more you raise this knob, the more drastic the effect.

This knob operates in addition to the Filter Frequency setting. This means that if you for example set the Frequency knob half-ways, the filter will be already half-open the moment you press a key. The envelope will then be used to open the filter *further*. Exactly *how much* further is determined by the Envelope Amount setting.

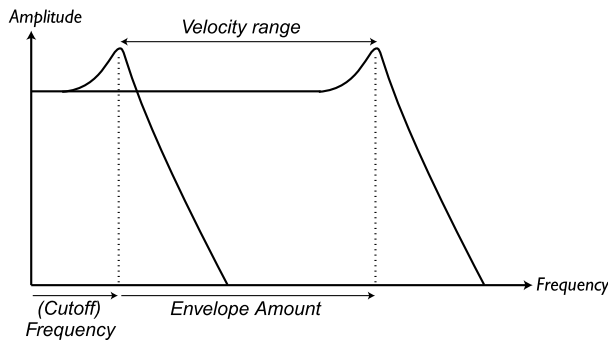

Set the initial cutoff frequency with the FREQUENCY knob. The Envelope Amount value is added to the initial cutoff value. If you select VELOCITY, the Envelope Amount value changes with Keyboard Velocity.

Let's take another example of the relation between Frequency and Envelope Amount: If the Filter Frequency knob is already turned fully right, the Envelope Amount setting has no effect at all, since the filter is already fully open the moment you press the key.

VELOCITY

When this switch is activated, the Envelope Amount varies with Velocity (how hard you play the keyboard). For this switch to have any effect, the Envelope Amount setting can't be set to zero (full left). Please note that more detailed velocity control can be achieved with the velocity programming function.

KBD TRACK

With this switch turned off (none of the indicators are lit), the Filter Frequency setting is constant regardless of where on the keyboard you play.

When Keyboard Track is activated, the filter frequency setting will be higher for higher notes as indicated in the illustration below. You can select between three degrees of Keyboard Track: 1/3, 2/3 and "full", as indicated by the LEDs above the button.

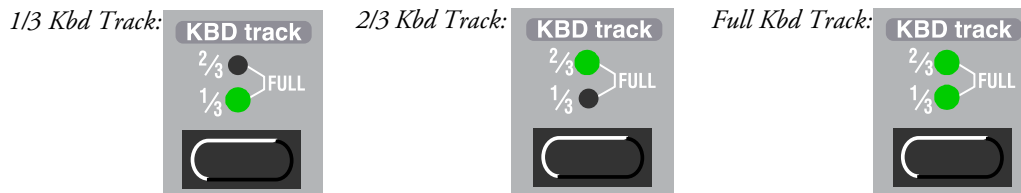

The reason for using the Keyboard Track switch is related to basic acoustics. If you raise the pitch of a waveform, the harmonics naturally raise in frequency. If the filter frequency is then constant, the sound

will be perceived as getting muddier the higher up the keyboard you play. To avoid this effect, use KBD Track.

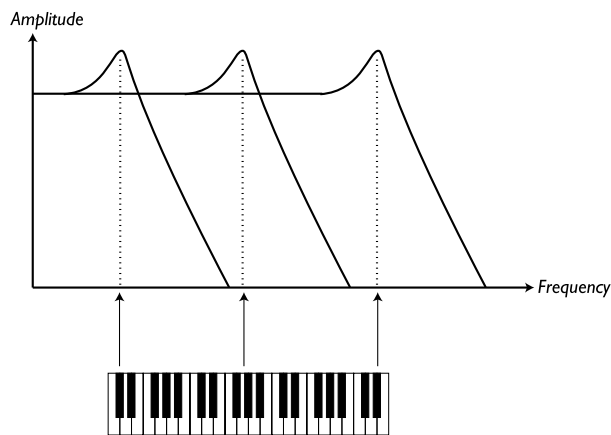

The figure shows how the Frequency value changes according to where on the keyboard you play when KBD TRACK is activated.

DISTORTION

When this is activated, the sound is slightly distorted, which adds some harmonics and creates a rawer, more screaming sound.

ATTACK, DECAY, SUSTAIN AND RELEASE



These are the parameters for the Filter Envelope. They are identical in functionality to the settings in the Amplifier Envelope, described on [page 44](#).

LFO 1

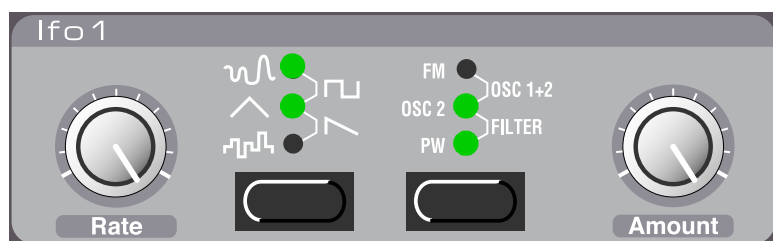

LFO stands for Low Frequency Oscillator. An LFO is an oscillator producing waveforms with a certain pitch, just like Oscillator 1 and 2. The differences are two:

- The LFOs produce waveforms with very low frequencies.

- You never hear the actual output of the LFO. Instead the output from the LFO is used for modulating, that is controlling, other functions, like for example the main oscillator frequency (vibrato) or the filter frequency (wah-wah).

WAVEFORM

This button is used to select the shape of the output from the LFO:

SOFT RANDOM

This adds smooth random modulation to the destination. This is mainly useful for effect sounds.

SQUARE

This is a waveform for “abrupt” modulation changes, suitable for trills, distinct tremolos, etc.

TRIANGLE

This is suitable for “normal vibrato” effects and for classic pulse width modulation.

SAWTOOTH

This creates a ramp which can be used for example for auto-repeats when applied to the filter.

RANDOM

This adds stepped random modulation to the destination. This is mainly useful for effect sounds.

RATE

This is used to set the frequency of the LFO, in other words “the speed of the vibrato”.

The rate can be controlled externally, via MIDI, see [page 68](#).

DESTINATION

This used to set which parameter the LFO should affect:

FM

This routes the LFO to the FM Amount, for special timbre changes.

Osc 1 + 2

This routes the LFO to the frequency of both oscillators, in equal amounts. Together with the triangle waveform this creates traditional vibrato.

Osc 2

This routes the LFO to the pitch of oscillator 2 only. This can for example be used together with Sync (see [page 43](#)) to create a “pulsating” change in timbre.

FILTER

This routes the LFO to the Filter Frequency. This can for example be used for wah-wah effects (triangle wave) and for auto repeating sounds (sawtooth wave).

PW

This routes the output of the LFO to the Pulse Width of both oscillators. For this to have any effect, pulse wave must of course be selected for at least one of the oscillators. This destination can be used with an LFO triangle waveform to create a “chorus-like” sound, suitable for strings and pads.

Please note that this function operates relative to the Pulse Width setting. For optimal results, please match the Pulse Width and LFO Amount settings (see below).

AMOUNT

This is used to set to what extent the signal from the LFO should be routed to the destination. Please note that the Amount can also be controlled from the Modulation wheel, see [page 59](#).

LFO 2/ARPEGGIATOR

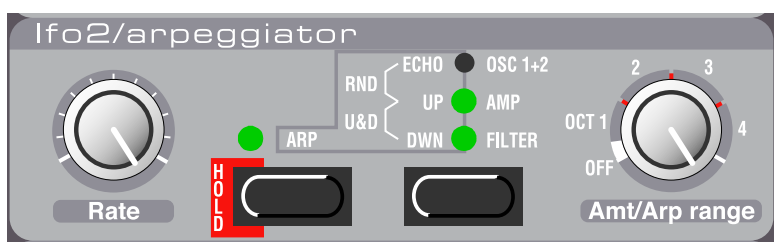

ARP SWITCH

This switch is used to select functionality for LFO 2. When the indicator over the button is lit or blinks, LFO 2 works as an arpeggiator (or an echo; see below). When the indicator is dark, it works as a regular LFO. On the following pages, these two modes are referred to as “Arpeggiator mode” and “LFO mode”.

When you leave Arpeggiator mode by pressing the Arp button, the Arpeggio will be turned off, but the LFO 2 function will not be activated until you press the right (LFO 2 Destination) button once. This lets you adjust the Rate and Amt knobs before applying vibrato, wah-wah or tremolo.

LFO 2: ARPEGGIATOR MODE

In this mode, LFO 2 works as an arpeggiator. If you take a chord and hold the keys depressed, the notes in the chord will be played back repeatedly, one after the other. The parameters govern direction, range and speed of the arpeggio:

RATE

This control adjusts the speed of the arpeggio.

When “Echo” is selected (see below), the Rate setting determines the “speed”, i.e. the delay-time between each note “echo”. A higher Rate setting gives a faster echo (shorter delay-time).

The arpeggio speed can also be controlled externally, via MIDI, see [page 68](#).

ARPEGGIO MODE

By pressing the button to the right in the LFO2/Arpeggiator version, you can select in which direction the arpeggio should run:

ARP UP

In this mode, the keys pressed on the keyboard will be played one after the other, from bottom to top, at a speed set with the Rate button. For more details, see Arp Range below.

ARP DOWN

As Arp Up but downwards.

ARP UP/DOWN

To get an up/down arpeggio, press the button until both Arp Up and Arp Down are lit.

RND ARP

In this mode (the two upper LEDs lit), Nord Lead 2X will create random arpeggios from the chords you play on the keyboard. This means that the notes in the chord are played back one at a time, but in random order and in random octaves.

ECHO

In this mode (The top LED lit), LFO2 creates an echo-effect by using repeated triggering with decreasing velocity (see explanation on the next page).

ARP RANGE

This knob is used to set the octave range of the arpeggio, as the panel indicates. The Off position turns off the arpeggio completely. When Echo is selected, this knob determines the number of echo repeats (0 – 8). You can select if you want the generated arpeggio notes to also be sent to MIDI Out. See [page 66](#).

ARPEGGIO HOLD

Normally, the arpeggio will continue for as long as you keep any keys depressed. By activating the Arpeggio Hold function, you can release the keys and have the arpeggio continue playing.

Activate Arpeggio Hold by holding down SHIFT and pressing the ARP SWITCH. The LED above the button blinks to indicate that Arpeggio Hold is activated. The arpeggio will continue to play until you press the ARP SWITCH again.

If the Arpeggiator is activated, but the ARP RANGE knob is set to “Off”, the Arpeggio HOLD switch will work as a regular Hold switch: If you play a note and release the key, the note will continue to sound, as if you were still pressing the key.

ABOUT THE ECHO FUNCTION

It is important to understand that the Echo function is not the same as a regular audio delay. What happens when you play a note with Echo activated, is that the same note is triggered (played) again the set number of times, with gradually decreasing velocity. This has the following consequences:

- If the sound you are playing is not sensitive to velocity (Filter Envelope Amount Velocity and Velocity/Morph are both turned off) there will be no difference whatsoever between the echo repeats.
- On the other hand, it is fully possible to use the Velocity/Morph function to make the sound change completely with the echo repeats, making the function ideal for special effects.
- The echo consumes polyphony, i.e. each echo repeat “steals” one voice, just as if you had played the repeats from the keyboard yourself. This should not be a problem when using the echo effect with short sounds, but if you play long, sustained notes with echo, you could experience notes being cut off by the echo repeats. The solution is to lower the Amt setting (decrease the number of repeats) and possibly play shorter notes.

- The echo function may give unexpected results if you use another Play mode than Poly. For example, in Mono mode, each sustaining note will be cut off by the next echo repeat and in Legato mode, you may end up with no sound at all, since new notes will not retrigger the envelopes.

LFO 2: LFO MODE

When “LFO Mode” is selected for LFO 2 (the Arp indicator is dark), LFO 2 works as a regular LFO, producing vibrato, wah-wah or tremolo effects. The parameters have the following functions:

RATE

This determines the rate (speed) of the modulation.

DESTINATION

OSC 1+2

When this is selected, LFO 2 produces a triangle wave routed to the pitch of Oscillator 1 and 2 in equal amounts – in other words, a regular vibrato.

AMP

When this is selected, LFO2 produces a triangle wave routed to the volume, for tremolo effects.

FILTER

When this is selected, LFO2 produces a triangle wave routed to the Filter Frequency, for wah-wah effects.

AMT

This determines the amount of modulation. Turn the knob to the right for more pronounced vibrato/tremolo/wah-wah.

MODULATION ENVELOPE



This is a simple type of envelope only comprising Attack, Decay and Amount controls. There's one difference between the way this envelope works compared to the other: It will start over from "zero" each time you press a new key, regardless of which value it had when you released the key.

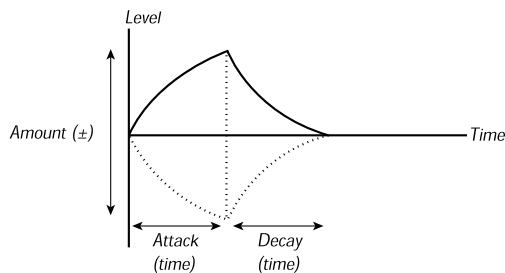

ATTACK

This is used to set the time it takes for the envelope to reach "full level" after you have pressed a key.

DECAY

When the attack phase is over, the envelope drops back to zero level. The Decay knob is used to set how long this should take.

AMOUNT

This is used to set to what degree the envelope should affect the destination. This knob is bi-polar, that is, zero amount is in the middle (twelve o'clock). Turning it left introduces a negative envelope and turning it right gives you a positive envelope.

DESTINATION

NONE

You can turn off both LEDs, to completely turn off the effect of the Modulation envelope. While this is the same as setting Amount to its centre position, this method is simply quicker.

FM AMT

When this is selected the envelope is routed to the amount of FM modulation. Varying the amount of FM changes the harmonic contents of the sound, so this can be used to have the timbre change pretty much like when the Filter envelope is used to change the Filter Frequency. **Please note that this parameter operates in addition to the FM amount setting in the Oscillator section.**

PW

When this is selected, the envelope changes the pulse width of the waveform from the oscillators (provided any of them have Pulse wave selected).

OSC 2

When this is selected, the envelope changes the pitch of Oscillator 2. This can be used in a number of situations. For example:

- With Sync to create distinct sweeping sounds.
- With FM for effect type sweeps.

To create “bleeps” in the beginning of a brass type of sound. Let us give a few examples:

If Attack is set to zero, and you have a positive Amount setting, Oscillator 2 pitch will decay down to normal pitch as set with the **DECAY** knob.

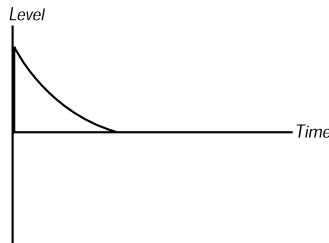

If Amount instead is set to a negative value, the pitch will rise up to “normal”.

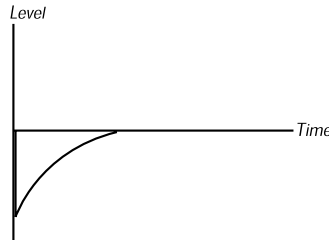

If Attack and Decay are both used and you have a positive Amount setting, the sound will start at normal pitch when you press the key, rise and then “fall back”.

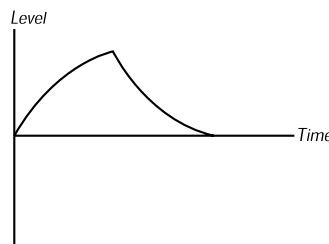

MOD WHEEL DESTINATION

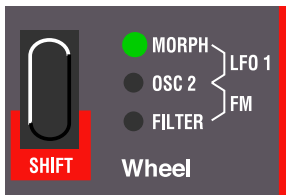

This button is used to decide what effect moving the MODULATION WHEEL should have.

MORPH

In this mode, the MODULATION WHEEL is used for morphing. See [page 27](#).

LFO 1

When this is selected (the two upper LEDs lit), the MODULATION WHEEL adjusts the amount of output from LFO 1. This allows you to for example add vibrato with the MODULATION WHEEL.

OSC 2

With this selected the MODULATION WHEEL is directly routed to Oscillator 2 pitch. This can be used for example together with Oscillator Sync and FM to vary the timbre of the sound while playing.

FM

When this is selected (the two lower LEDs lit), the MODULATION WHEEL controls the amount of FM (see [page 41](#)).

FILTER

This routes the MODULATION WHEEL directly to the Filter Frequency parameter.

Please note that Modulation Wheel routing is in addition to the basic setting of the control it is routed to. If you for example route the Modulation Wheel to the filter, and the filter is already fully open, moving the MODULATION WHEEL has no effect.

POLY, LEGATO, MONO

The “play mode” switch and LEDs:

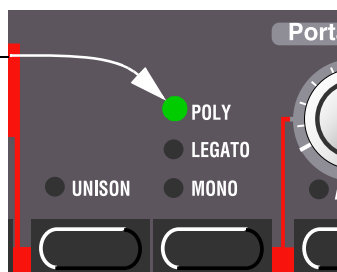

The “play mode” switch is used for deciding exactly how your keyboard playing should be interpreted by the synthesizer:

POLY

This mode allows you to play chords.

LEGATO

This makes the instrument monophonic. Furthermore, if you press a key without releasing the previous one, the pitch will change, but the envelopes will not retrigger. That is, there will be no new “attack”.

MONO

This also makes the instrument monophonic. But if you press a key without releasing the previous one, the envelopes are still retriggered, like when you release all keys and then press a new one. Furthermore if you press a key, hold it, press a new key and then release that, the first note is also “retriggered”.

UNISON

The Unison switch and LED.

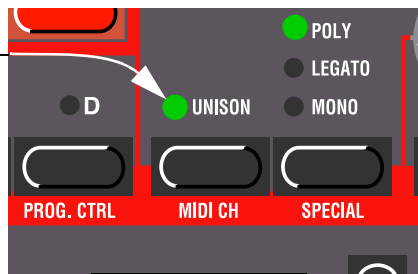

When this is activated more than one voice will be played when you press a key. This gives you a “fatter” sound, but at the same time reduces polyphony.

- If Poly mode is selected, two voices are used for each key. This allows you to play eight notes at the same time (provided you are not using Layers).
- If Mono or Legato mode are selected, four voices are used for each key, for an even fatter sound.

PORTAMENTO

The Portamento controls.

PORTAMENTO (TIME)

This is used to set how long it should take for the pitch to slide from one pitch to the next. If you don’t want any Portamento at all, set this knob to zero.

AUTO

When Auto is activated (LED is lit), the pitch only slides if you play legato, that is if you play a new key before releasing the previous one.

The effect of Auto Portamento is pretty obvious when you have selected Mono or Legato “Play mode”. If, on the other hand, Poly is selected, the Portamento effect will be slightly unpredictable if Auto is on. For Poly mode, we therefore recommend you to turn Auto off.

OCT SHIFT

The OCTAVE SHIFT buttons have two functions, Slot and Keyboard Octave Shift (explained below). To switch between the two Octave Shift modes, simultaneously press both OCTAVE SHIFT buttons and hold them depressed until the LEDs change indication mode, as shown in this figure:

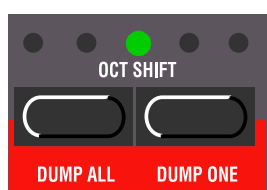

Slot Octave Shift (default)

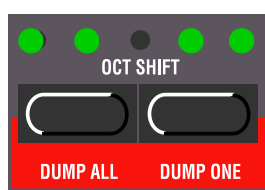

Keyboard Octave Shift (LEDs inverted)

SLOT OCTAVE SHIFT

This mode will automatically be selected each time you turn on the Nord Lead 2X. In this mode, the Octave Shift buttons affect the Program in the selected slot only. Notes sent to MIDI Out are not transposed. This means that in this mode, the Nord Lead 2X can only send MIDI Notes over a range of 4 octaves.

KEYBOARD OCTAVE SHIFT

In this mode (LEDs inverted), the actual *keyboard* is affected by the Octave Shift buttons. This means that *all* active slots are affected, as well as all notes sent to MIDI Out. This mode is suitable if you want to control other MIDI instruments from the Nord Lead 2X, since it lets you control a note range of eight octaves. It is also the mode to use if you're playing a Performance consisting of two or more slots, and want to be able to Shift all slots simultaneously.

Note: Low/high octave settings in combination with extreme Tune settings for Oscillator 2 may produce pitches outside the hearing range.

9. SHIFT FUNCTIONS

ACCESSING THE SHIFT FUNCTIONS

Some functions do not have dedicated buttons, but share buttons with other functions and settings. These are called the *Shift Functions* and are printed in blue on the front panel.

SELECTING A SHIFT FUNCTION

1. Hold down the Shift button.
2. Press any of the buttons labelled “Tune” to “System”. Most of the front panel LEDs go out and the DISPLAY shows the selected function.

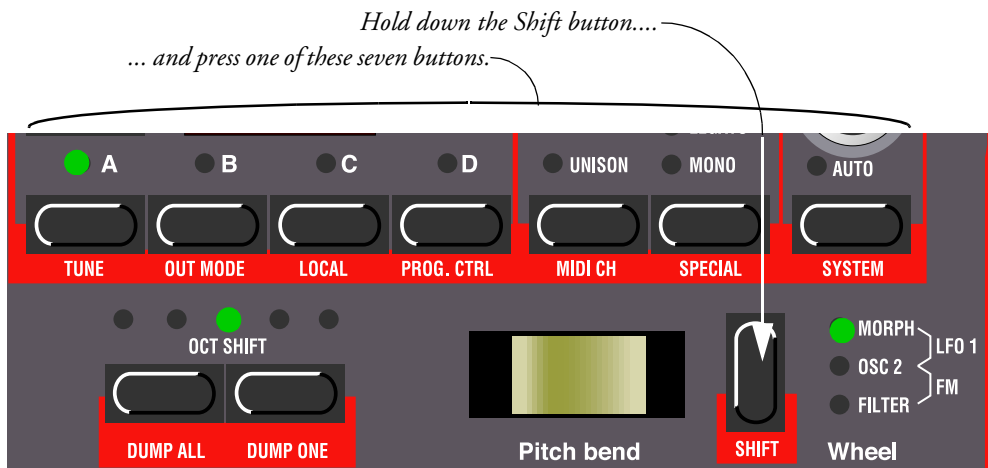

3. If the Function button you pressed is used for more than one parameter, press it repeatedly until the DISPLAY shows the desired function. If you for example selected the “PRG.CTRL” button, the left digit in the display switches between ‘P’ (Program), ‘C’ (Controllers) and ‘A’ (Arpeggiator MIDI send) when you press it.

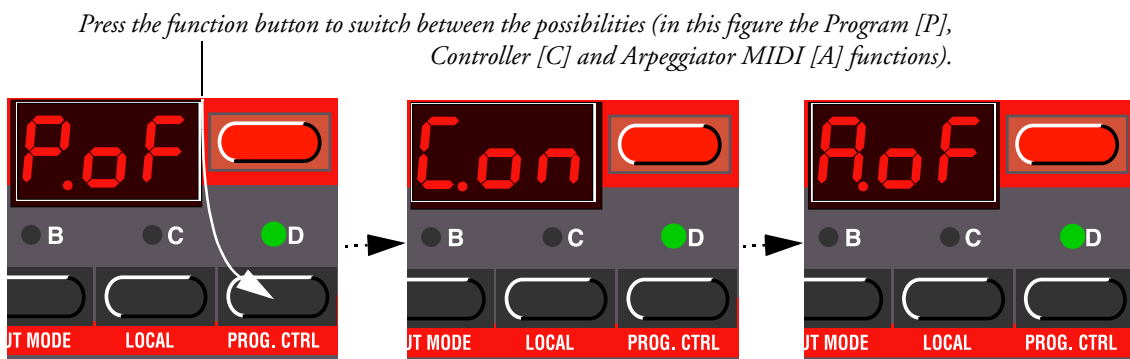

When a Function button is used for more than one parameter, the digit to the left in the display indicates the parameter, and the other digits show the value.

SHIFT FUNCTION LIST

The table below shows you what Shift functions are available for each of the seven buttons and an example of what the DISPLAY can look like for each function.

TUNE	OUT MODE	LOCAL	PROG. CTRL	MIDI CH	SPECIAL	SYSTEM
<i>Master Tune</i>	<i>Out Mode for Slots A and B</i>	<i>Local On/Off</i>	<i>Prog. Change On/Off</i>	<i>Slot MIDI Channel</i>	<i>LFO 1 Sync</i>	<i>Sustain Pedal Polarity</i>
	<i>Out Mode for Slots C and D</i>		<i>Controllers On/Off</i>	<i>Global MIDI Channel</i>	<i>LFO 2/Arp Sync</i>	<i>Pitch Bend Range</i>
			<i>Arp. MIDI Out On/Off</i>		<i>Filter Envelope Trig</i>	<i>Unison Detune</i>
					<i>Amplitude Env. Trig</i>	
					<i>External Velocity Morph</i>	
					<i>Aftertouch Assignment</i>	
					<i>Control Pedal Assignment</i>	

Each time you turn on Power, Local On/Off is set to On, and all the Special functions are turned off! (However, the Special settings are saved with the Performances).

ABOUT GLOBAL AND SLOT FUNCTIONS

- If the function you select can be set independently for each Slot (A to D), the selected Slot LED flashes. To make settings for a specific Slot, select it by pressing the SLOT button.
- If the selected function is global for all Slots, the selected SLOT button is steadily lit. Which Slot is selected is then of no relevance for the setting.

SETTING THE VALUE

Once a function is selected, the value is set using the UP/DOWN buttons.

EXITING THE SHIFT FUNCTIONS MODE

To go back to the regular “play mode”, press the SHIFT button once again.

There is no need to store the Shift function settings. The settings will be stored automatically to the memory. However, some functions are always reset to default values when you turn off power (see the description of each Shift function for details).

TUNE (MASTER TUNE)

This function is used to tune the Nord Lead 2X to other instruments. ‘00’ is normal 440Hz tuning. Lower pitches are indicated by a dot to the right of the number and values higher than normal pitch are indicated without a dot. The values are in cents (hundreds of a semitone).

OUT MODE

This function is used to set how the sound should be routed from the Slots to the Outputs. The Out Mode settings are global for the entire instrument, which means all Programs share the settings made here.

Nord Lead 2 has four outputs, labelled A-D. It might be a good idea to think of these outputs as two output pairs (A-B and C-D), because that is often how they are used.

Basically there are three possibilities for how a sound appears in the outputs:

- The first is that a Program appears with equal level at two outputs, which is what we refer to as *mono*.
- The second option is that the voices (the keys you play) appear alternating between the two outputs in an output pair (A-B or C-D). This we refer to as *stereo*. If you play chords in stereo mode, the sound will be spread out in the stereo image.
- When Unison is activated, more than one voice will be used each time you press a key, as described on [page 60](#). If a Unison Program is played in stereo mode, each time you play a key you will get at least one voice at one output in a pair and at least one at the other, which will result in a “wide” stereo sound.
- The third option is that when playing several Programs at the same time, the different Programs appear separated on different outputs.

The Out Mode function allows you to set different output modes for Slots A/B and C/D:

- To set the output mode for Slot A and B, hold down **SHIFT** and press the “**OUT MODE**” button once. Note however, that the setting you make for Slot A and B can affect Slot C and D as well, if the setting ‘-cd’ is selected for Slot C and D, as described below.
- To set the output mode for Slot C and D, hold down **SHIFT** and press the “**OUT MODE**” button twice. Pressing the button repeatedly will toggle between the settings for Slots A/B and C/D.

SETTINGS FOR SLOT A AND B:

Display	Description
1.Ab	In this mode, all sounds are mono (as described above), except if Unison is activated in which case the instrument automatically switches to stereo, using Outputs A and B. If one Unison and one non-unison Program are layered, <i>stereo</i> is used.
2.Ab	This is a straight Mono mode. All Programs always appear with equal level at Outputs A and B.
3.Ab	This is a straight stereo mode. All Program always appear with voices alternating between Outputs A and B.
4.Ab	In this mode Programs assigned to slot A will appear at Output A, while Program assigned to slot B will appear at Output B. This mode can be used when it is desired to treat two sounds differently in an external mixer, for example in multitimbral MIDI work or when layering sounds.

SETTINGS FOR SLOT C AND D:

Display	Description
-cd	In this mode, Slot C and D use the settings made for Slot A and B. If for example mode “ab2” is selected, all four slots will appear in Mono at Outputs A and B. This is the setting you should use if you have connected Nord Lead 2 in stereo to your sound equipment (using Outputs A and B), or if you are using headphones.
1.cd	In this mode, all sounds are output in mono at Outputs C and D, except if Unison is activated. If that is the case, the instrument automatically switches to stereo, using Outputs C and D. If one Unison and one non-unison Program are layered, <i>stereo</i> is used.
2.cd	This is a straight Mono mode. All Programs always appear with equal level at Outputs C and D.
3.cd	This is a straight stereo mode. All Program always appear with voices alternating between Outputs C and D.
4.cd	In this mode Programs assigned to slot C will appear at Output C, while Program assigned to slot D will appear at Output D. This mode can be used when it is desired to treat two sounds differently in an external mixer, for example in multitimbral MIDI work or when layering sounds.

Mode 1 (1.Ab or 1.cd) is not recommended when using the Nord Lead 2X multitimbrally since one Program can be set to Unison and another not, which might lead to a stereo image you might not expect.

LOCAL

This is used to turn MIDI Local Control on and off.

- Local On is the normal Play Mode.
- In Local Off mode, the front panel actions and your keyboard playing are transmitted via MIDI, but are *not used to play the synthesizer directly*. MIDI Input, however, works normally. This mode should be used when you're working with sequencers, when the Nord Lead 2X is used both for recording and playing back MIDI, and when the sequencer has a MIDI Thru function (sometimes called "Merge" or "echo-back").

When you turn on power, the instrument is always in MIDI Local On mode.

ABOUT LOCAL CONTROL AND CONTROL CHANGE TRANSMISSION

The Local Control setting also affects the front panel.

- In Local Off mode the front panel controls can *not* be used to change the sound directly, they must be routed via MIDI, just as the keyboard.
- However, if you use the Prog/Ctrl function to turn off reception and transmission of Control Change messages altogether, the front panel controls *can* again be used to change the sound directly, since otherwise there would be no way to use the front panel controls at all.

PROG/CTRL

This is used for setting how Program Change and MIDI Control Change messages should be handled, and for turning the Arpeggio MIDI Out feature on and off.

These parameters are Global for the entire instrument, that is, the settings are valid for all Programs and Performances.

To switch between the three different parameters, hold down **SHIFT** and press the **PROG/CTRL** button. The left character in the **DISPLAY** switches between 'P' (Program), 'C' (Control) and 'A' (Arpeggio).

For the two first parameters ('P' and 'C') you use the **UP/DOWN** buttons to switch between 'oF' and 'on'. The 'oF' value means that no data of that type is transmitted or received; 'on' means that type of data is both transmitted and received. The Arpeggio MIDI Out feature requires some explanation:

ARPEGGIO AND MIDI OUT

If you want to, all notes in a generated arpeggio can be sent out as MIDI notes. This makes it possible to arpeggiate notes on connected synthesizers and sound modules, and to record arpeggios in a sequencer. You activate it using the Prg. Ctrl. menu:

1. Hold down Shift and press the Prg/Ctrl button to select parameter. The left character in the **DISPLAY** switches between 'P' (Program), 'C' (Control) and 'A' (Arpeggio).
2. Use the **UP/DOWN** buttons to switch between 'A.oF' and 'A.on'.

- For the Program and Control parameters, the ‘on’ setting means that the respective MIDI data is transmitted and received by the Nord Lead 2X, while the ‘oF’ setting means that it is not.
- For the Arpeggio parameter, the ‘A.on’ setting means that generated arpeggios can be sent out as MIDI notes. This makes it possible to arpeggiate chords on connected synthesizers and sound modules, and to record arpeggios in a sequencer. With the ‘A.oF’ setting, the actual chord you play on the keyboard is sent to MIDI Out, regardless of whether the Nord Lead 2X arpeggio is activated or not.

Be sure to turn the Arpeggio MIDI Out feature off if you are using Nord Lead 2X in Local Off mode and/or in a “Thru-loop” with a sequencer, other MIDI instruments etc! Under such conditions, the Arpeggio MIDI Out feature will either prevent the instrument from sounding at all, or cause a MIDI feedback loop.

MIDI CHANNEL

SLOT MIDI CHANNEL

To set the MIDI Channel that a certain Slot receives and transmits on, proceed as follows:

1. Hold down **SHIFT** and press “**MIDI CH**”.
2. The **DISPLAY** shows the MIDI Channel for the active Slot.
3. Select the Slot you want to make settings for. The Slot’s **LED** flashes.
4. Use the **UP/DOWN** buttons to set the MIDI Channel. If you don’t want the slot to respond to or send MIDI, set it to ‘oF’.

For more information on Slots and MIDI Channels, see [page 76](#).

GLOBAL MIDI CHANNEL

This is the MIDI Channel used for transmitting and receiving Program Change messages for switching between Performances. To set the Global MIDI Channel, proceed as follows:

1. Hold down **SHIFT** and press “**MIDI CH**”.
2. Press “**MIDI CH**” again. The **DISPLAY** now shows the Global MIDI Channel.
3. Use the **UP/DOWN** button to set the Global MIDI Channel.
Note that the Global MIDI Channel should NOT be set to the same as any of the Slot’s MIDI Channels to avoid conflicts.

For more information on the Global MIDI Channel, see [page 76](#).

SPECIAL

There are five special functions that make it possible to use MIDI for functions that have previously been reserved for users of analog modular synthesizer systems.

ACCESSING THE SPECIAL FUNCTIONS

1. Hold down SHIFT and press SPECIAL.
2. Press the Special button as many times is need to make the left digit in the display show the desired function ('1', '2', 'F', 'A', 'S', 't' and 'E').
3. Select the Slot (A to D) that you want to make settings for.
4. Use the UP/DOWN buttons to set values (the right digit).

The Special functions can be set up differently for each Slot and each Slot can use all and any of the Special functions at the same time, if desired.

FUNCTION "1" – SYNCHRONIZING LFO 1 TO MIDI CLOCK

For this to work you need to feed a MIDI Clock signal from a sequencer or similar into the MIDI In of the Nord Lead 2X and activate Play in the sequencer so that MIDI Clock is actually transmitted.

The function synchronizes LFO1's start to the incoming MIDI Clock so that the LFO starts over at certain intervals. Which interval to use is set with the parameter value:

Value	Description
1.oF	No external Sync
1. 1	Restart every other bar
1. 2	Restart every whole note
1. 3	Restart every half note
1. 4	Restart every quarter note
1. 5	Restart every eighth note
1. 6	Restart every eighth note triplet
1. 7	Restart every sixteenth note

Please note that this only makes the LFO restart at the specified note value. In between those restarts, the LFO runs at the rate set with the RATE knob. Therefore, to "hard sync" the LFO to the tempo of the song when triangle or sawtooth waves are used, set the LFO rate as close to the tempo in the sequencer as possible. On the other hand, unusual Rate values can lead to interesting rhythmic effects.

When random is selected (or when the Arpeggio is used, see below), to "hard sync", you only need to make sure the set Rate is lower than the rate imposed via MIDI.

AN EXAMPLE OF LFO 1 SYNCHRONIZATION

1. Select a Program for Slot A, that plays a "stable" sound with high sustain, for example a "string" or "pad" sound.

2. Lower the Filter Envelope **AMOUNT** to 0.
3. Set the Filter Cutoff **FREQUENCY** to “nine o’clock”.
4. In the LFO section, select a sawtooth wave, set **DESTINATION** to Filter and set the **AMOUNT** to full value.
5. Play the keyboard. You should hear a repeating sound.
6. Hold down **SHIFT** and press **SPECIAL**. The **DISPLAY** should show the setting for Special function 1.
7. Press the **SLOT A** button.
8. Use the **UP/DOWN** buttons to set the value to ‘5’ (eighth notes).
9. Make sure all other Special functions are turned off for Slot A. Do this by pressing the **SPECIAL** button repeatedly and check that the left digit in the **DISPLAY** is set to ‘oF’ for all Functions except “1”.
10. Press **SHIFT** again to return to “normal mode”.
11. Set up your sequencer (or other MIDI device) to transmit MIDI clock to the Nord Lead 2X. Set the tempo to around 120 BPM and activate Play in the sequencer/device so that MIDI clocks are actually transmitted.
12. Play the Nord Lead 2X keyboard and adjust the **RATE** knob in the LFO 1 section. Start at approximately 12 o’clock and adjust until you get eighth notes that are in sync with the sequencer. If you raise the Rate slightly from this position you’ll get a shuffle 16th note repeat, etc.

FUNCTION “2” – SYNCHRONIZING LFO2/ARPEGGIO TO MIDI CLOCK

This works exactly as the Special 1 function, only it operates on LFO 2 and the Arpeggio instead. **Please note that the explanation about the relation between the LFO rate and the restart via MIDI Clock also applies to the Arpeggio.**

Note: this function will not be enabled when Echo is selected on LFO2.

FUNCTION “F” – EXTERNAL TRIGGERING OF FILTER ENVELOPE

This function can be used to trigger the Filter envelope via notes coming in via MIDI, instead of by playing the keyboard. The Filter envelope is triggered from its own MIDI Channel and note number(s), completely independent of the MIDI Channel used for defining which keys should be played. This can be used to play back preprogrammed rhythms in your MIDI sequencer while inputting the actual pitch(es) by playing the keyboard or via MIDI.

Use the **UP/DOWN** buttons to switch between ‘oF’ and ‘on’.

To set which MIDI Channel and possibly which MIDI note number to use for triggering, do like this:

1. Activate the function by holding down **SHIFT** and pressing the **SPECIAL** button three times.

2. Select 'F.on' with the UP/DOWN buttons.
3. Press STORE. The DISPLAY shows the MIDI Channel currently used. Set the MIDI Channel with the UP/DOWN buttons.
4. Press STORE again. The DISPLAY shows which MIDI Note number is currently used. The numbers start at C0 (MIDI note number 24), and sharp notes (#) are indicated by the symbol **H**. "Middle C" is displayed as 'C3'. Select MIDI Note number, either by pressing a key on the keyboard, or by selecting one with the UP/DOWN buttons. The value '---' means that note number is ignored and that all notes on the set MIDI Channel will be used for triggering. This value is found below all the "note number values".

GUIDELINES FOR USING FILTER ENVELOPE TRIGGERING

- If you have notes transmitted from your sequencer that you want to use *only* for triggering the envelope, make sure the MIDI Channel you use for this function is not used by any of the Slots.
- Please note that if the Velocity function in the Filter section is activated, the velocities of the incoming MIDI notes are routed to Filter Envelope amount. This allows you to adjust the timbre of the sound with the velocity of the incoming MIDI notes.

AN EXAMPLE OF FILTER ENVELOPE TRIGGERING

1. Select a Program for Slot A, that plays a stable sound with high sustain, for example a "string" or "pad" sound.
2. Lower the Filter Cutoff FREQUENCY to 0.
3. Raise the Filter ENVELOPE AMOUNT and adjust the Filter envelope so that the sound has a short, snappy character.
4. Hold down SHIFT and press MIDI CH. Set the MIDI Channel for Slot A to '1'.
5. Press each of the other SLOT buttons and set them to MIDI Channel '16'. This is just to make sure they do not get used in this example.
6. Hold down SHIFT and press SPECIAL.
7. Press the SPECIAL button until the left digit in the DISPLAY reads 'F'.
8. Make sure Slot A is selected. Otherwise press the SLOT A button.
9. Use the UP/DOWN buttons to set the value to 'F.on'.
10. Press STORE. Use the UP/DOWN buttons to select MIDI Channel '2'.
11. Press STORE again and then the DOWN button to select '---' (any MIDI note number).
12. Press STORE again.

13. Make sure all other Special functions are turned off for this Slot. Do this by pressing the SPECIAL button repeatedly and check that the left digit in the display is set to 'oF' for all Functions except 'F'.
14. Press SHIFT again to return to "normal mode". If you play the keyboard now, you will not get any sound, because the Cutoff FREQUENCY is all the way down, and the Filter envelope is no longer triggered by the keyboard.
15. Set up your sequencer to play a simple repeating note pattern on MIDI Channel 2. The pitches of the notes does not matter, only the rhythm.
16. Hold down a few keys on the keyboard and start the sequencer. The keys you press should now be played with the rhythm from the sequencer.

FUNCTION "A" – EXTERNAL TRIGGERING OF AMPLIFIER ENVELOPE

This function can be used to trigger the Amplifier envelope via notes coming in via MIDI, instead of by playing the keyboard. Just as with the previous function, this can be used to play back preprogrammed rhythms in your MIDI sequencer while inputting the actual pitch(es) by playing the keyboard.

You must play keys on the keyboard, or via MIDI (on the Slot's MIDI Channel), to get any sound!

The parameters are the same as for the Filter Envelope function, see above.

If this function is activated and no MIDI notes are triggering the Amplifier envelope, the instrument will be silent!

FUNCTION "S" – EXTERNAL VELOCITY MORPH

This function is used to control the Velocity/Morph function via the velocity numbers of incoming MIDI notes.

This differs from the way Velocity/Morph is normally applied. Normally the velocity is applied each time you press a key. With the External Velocity Control function, however, you can press and hold notes and vary their timbre via the velocity of the incoming notes *without* releasing the keys (that is – without re-triggering the envelopes).

You can use the UP/DOWN buttons to switch between 'oF' and 'on'.

The velocity control happens on its own MIDI Channel and note number(s), completely independent of the MIDI Channel used for defining which keys should be played. It can be controlled from *all notes* on *one* MIDI Channel or *one specific note number* on *one* MIDI Channel (see Function 3 above for how to specify the MIDI note number and the MIDI Channel).

- When this function is activated, and a MIDI Note On message comes in, the parameters' values are adjusted according to the note's Velocity value.
- When a MIDI Note Off message comes in, the Velocity/Morph function is reset to the minimum value.

Please note that you must play the keyboard to hear anything. Also note that the Velocity/Morph must be set up beforehand for this function to have any effect on the sound.

AN EXAMPLE OF EXTERNAL VELOCITY MORPH

1. Select a Program for Slot A.
2. Edit the Program so that you get a morphing effect you like when you move the MODULATION WHEEL. It is not actually necessary to assign the velocity programming to the MODULATION WHEEL, but it is a practical way to try out the effect before you apply it via MIDI.
3. Hold down SHIFT and press MIDI CH. Set the MIDI Channel for Slot A to '1'.
4. Press each of the other SLOT buttons and set them to MIDI Channel '16'. This is just to make sure they do not get used in this example.
5. Hold down SHIFT and press SPECIAL.
6. Press the SPECIAL button until the left digit in the display reads 'S'.
7. Make sure Slot A is selected. Otherwise press the SLOT A button.
8. Use the UP/DOWN buttons to set the value to 'on'.
9. Press STORE. Use the UP/DOWN buttons to select MIDI Channel '2'.
10. Press STORE again and then the DOWN button to select '---' (any MIDI note number).
11. Press STORE again.
12. Make sure all other Special functions are turned off for this Slot. Do this by pressing the SPECIAL button repeatedly and check that the left digit in the display is set to 'oF' for all Functions except 'S'.
13. Press SHIFT again to return to "normal mode". If you play the keyboard now, there will not be any velocity control because you have set the instrument up to only do this on a separate MIDI channel.
14. Set up your sequencer to play a sequence of notes with drastically different velocity values. The pitches of the notes does not matter, only the rhythm and velocity.
15. Hold down a few keys on the keyboard and start the sequencer. The sound should now vary in character with the velocity values coming out from the sequencer.

AFTERTOUCH AND EXPRESSION PEDAL SETTINGS

The Special menu also contains settings for Aftertouch ('t') and Expression pedal ('E') parameter assignment. These functions are described in their respective contents on [page 19](#) (Expression pedal) and [page 74](#) (Aftertouch).

SYSTEM

Under this menu you will find three different functions, labelled 'SP', 'br', and 'Un'.

To select one of the functions, hold down **SHIFT** and press the **SYSTEM** button. Then press the **SYSTEM** button repeatedly until the left digit in the **DISPLAY** shows the desired letter.

SUSTAIN PEDAL (SP)

This is used to set the polarity of a connected Sustain pedal. See [page 19](#) for details.

This parameter is global for the entire instrument, that is, the setting is valid for all Programs and Performances.

PITCH BEND RANGE (BR)

This allows you to set the range of the **PITCH STICK**, in semitones. The value is also used to set what effect incoming pitch bend MIDI messages should have on the pitch.

The table below shows you how many semi-tones each value in the display represents.

Setting	Range in semitones
1	±1
2	±2
3	±3
4	±4
5	±7

Setting	Range in semitones
6	±10
7	±12
8	±24
9	±48

This parameter is global for all Slots. However, it is saved with a Performance which means you can have different pitch bend ranges for different Performances.

UNISON DETUNE (UN)

This allows you to set how far detuned the voices should be when you have Unison activated. For more info on Unison, see [page 60](#).

This parameter is global for all Slots. However, it is saved with a Performance which means you can have different Unison values for different Performances.

10. MIDI

ABOUT THE MIDI IMPLEMENTATION

The following MIDI messages can be transmitted and received from the Nord Lead 2X:

NOTES

- Note On and Off messages are of course transmitted when you play the keyboard. If you use the OCTAVE SHIFT buttons in their “Keyboard” mode (see [page 61](#)), you can shift the Nord Lead 2X keyboard ± 2 octaves, giving you an effective keyboard range of 8 octaves.
- Notes can be received over the entire MIDI range. That is, when playing via MIDI you have access to a pitch range wider than 10 octaves.

PITCH BEND

- Pitch Bend messages are always transmitted from the PITCH STICK.
- The Pitch bend range (used when receiving pitch bend messages) can be adjusted, see [page 73](#).

CONTROLLERS

- The MODULATION WHEEL is transmitted and received via MIDI as Controller 1 (Modulation wheel).
- If you have an Expression pedal connected to the CONTROL PEDAL input, this is transmitted as Controller 11.
- If you have a Sustain pedal connected, this is transmitted as Controller 64 (Damper Pedal).
- All other controls (knobs and switches) on the front panel (except MASTER LEVEL), are also transmitted and received as Control Change messages. This can be used to record your actions on the front panel into a MIDI sequencer, for playback together with the musical performance. For a full list of which parameters correspond to which Controller number, see the MIDI Implementation section on [page 103](#).





You can activate/deactivate transmission/reception of the front panel Controllers, see [page 66](#).

AFTERTOUCH

The Nord Lead 2X can receive (but not send) Aftertouch (channel pressure) messages. You can set which parameter (if any) should be controlled by the Aftertouch messages for each Slot:

1. While holding down the SHIFT button, press the SPECIAL button.

2. Press the **SPECIAL** button repeatedly, until the left character in the Display reads ‘t’ (for “touch”).
3. Select a Slot for which you want to set the aftertouch function.
4. To assign a parameter for the aftertouch, press **STORE**. The **DISPLAY** will flash, showing one of the abbreviations in the table below.
5. Use the **UP/DOWN** buttons to select one of the following control functions:

Display shows:	Aftertouch assigned to:
	LFO 1 Amount.
	LFO 2 Amount.
	Filter Cutoff Frequency.
	FM Amount.
	Oscillator 2 Pitch.

6. After you have made your choice, press **STORE** again. You return to the ‘t’ display.
7. Use the **UP/DOWN** buttons to select a control amount value (‘oF’ or ‘1’ to ‘7’). This value (shown to the right in the **DISPLAY**) determines how much the assigned parameter should be affected by a received maximum aftertouch value. If you don’t want the Slot to be affected by aftertouch messages, select the amount value ‘oF’.
8. If needed, repeat steps 3 to 7 to set aftertouch assignment for the other Slots.
9. Press **SHIFT** to exit the Special menu and return to “play mode”.

PROGRAM CHANGE

The descriptions below are only true if transmission/reception of Program Change messages is activated, see [page 66](#).

- When you select a new Program for a Slot, a Bank Select (see below) and Program Change message is transmitted via MIDI, on the *Slot's* MIDI Channel.
- Likewise, if a Program Change message is received on a certain MIDI Channel, all Slots set to that MIDI Channel will switch to a new Program.

- When you select a new Performance, a Bank Select (see below) and Program Change message is transmitted on the *Global* MIDI Channel. For information on how to set the Global MIDI Channel, see [page 67](#).
- When a Program Change message is received on the Global MIDI Channel, a new Performance is selected.

If the Global MIDI Channel happens to be set to the same number as one of the Program slots, the Performance takes precedence. That is, Program Change messages on this MIDI Channel will select Performances, not Programs.

BANK SELECT

Bank Select messages are transmitted and received as MIDI Controller 32.

Bank Select messages are used to determine which Program/Performance Bank is currently used. Every Program Change sent from the Nord Lead 2X is preceded by a Bank Select message. The lowest Bank Select number '0' selects the first Bank, Bank select number '1' selects the second Bank and so on. Bank Select must always be used in combination with Program Change, or no Bank change will take place.

SYSTEM EXCLUSIVE

Program settings can be transmitted as a System Exclusive "bulk dump". See [page 78](#).

USING NORD LEAD 2X WITH A SEQUENCER

CONNECTIONS

1. Connect MIDI OUT on the Nord Lead 2X to a MIDI In on your sequencer.
2. Connect a MIDI Out from your sequencer to the MIDI IN on the Nord Lead 2X.

LOCAL ON/OFF

If your sequencer "echoes" all received MIDI signals via its MIDI Output(s) (which it probably does, look for a function called "MIDI Thru", "MIDI Echo", "MIDI Merge", "Soft Thru" or similar), the Nord Lead 2X should be set to MIDI Local Off. See [page 66](#).

MIDI CHANNELS

- Which MIDI Channel the Nord Lead 2X *transmits* on depends on which of the four Slots is active (see [page 15](#)).
- All four Slots always *receive* MIDI, regardless of which one is selected, or if layering of one or more Slots is activated or not. However, all Slots used in a Layer (i.e. all Slots that are activated) will *also* receive on the MIDI channel set for the leftmost active Slot! This means that if you have a layer consisting of Slots A, B and D, and Slot A is set to MIDI channel 1, both Slots B and D will receive on MIDI channel 1, as well as on their respective set MIDI channels.

Therefore, if you want the sequencer to control the four Slots independently (i.e. not in a layer), make sure only one of the Slots is active on the Nord Lead 2X (only one Program Slot LED is lit)!

1. Set up the Slots that you plan to use so that they transmit/receive on the desired MIDI Channels. To set a Slot's MIDI Channel, hold down **SHIFT**, and press **MIDI CH**. Then select the Slot, and set the value. See [page 67](#) for details.
2. Set the program Slots that you *don't* plan to use, to MIDI Channel 'oFF'. This is to ensure they don't play any sound unintentionally.
3. Select the desired Program for each Slot.
4. If your sequencer requires you to transmit on a certain MIDI Channel (the same MIDI Channel as the Slot receives on), select the desired Slot, before recording.
5. If needed, set the sequencer up to record and play back on the desired MIDI Channel.
6. Activate recording and play the Nord Lead 2X.
7. For an overdub with a new sound, select a new Track with a new MIDI Channel in the sequencer.

PROGRAM CHANGE

For the Nord Lead 2X to transmit and receive Program Change messages, Program Change must be activated, see [page 66](#).

- To record a Program Change for a certain Slot, activate recording in the sequencer and simply select a new Program for the Slot.
- To record a change of Performance, enter Performance mode, activate recording in the sequencer and select the Performance with the **UP/DOWN** buttons.

When playing back the Performance Program Change message from the sequencer, make sure it gets transmitted on the Nord Lead's Global MIDI Channel (see [page 67](#)).

CONTROLLERS

For the Nord Lead 2X to transmit and receive Control change messages from the front panel this must be activated, see [page 66](#). Modulation Wheel and pedal, however, are always transmitted/received.

- When you record front panel movements, make sure you have the right Slot activated, and that the sequencer "echoes" the changes back on the right MIDI Channel, or your changes will affect the wrong sound!
- If two (or more) Slots are set up to receive on the same MIDI Channel, both will be affected by the changes!
- Please read the note about Controller transmission in Local Off mode on [page 66](#).

SOME NOTES ABOUT CONTROLLERS AND “CHASING”

Consider a situation in which you record a Controller message, e.g. a filter opening, in the middle of your sequencer song. Then you “rewind” the sequencer, to a position before the recorded filter opening. The problem is, that the Nord Lead’s filter will remain opened, although it really should be as it was before you recorded the filter opening. To solve such problems, several sequencers include a function called “chasing”, which keeps track of Controller changes and tries to adjust the settings on the instrument according to the current position in the sequencer song.

However, in our case, this wouldn’t help much, because the filter opening was the *first* Controller message recorded in the song. The sequencer has no information about the filter setting before the recorded change, and therefore cannot “chase” the settings properly. To solve this, you could record a “snapshot” of all Controller settings on the Nord Lead 2X panel, at the beginning of your sequencer song. This is best done by sending an “All Controllers Request” SysEx message from the sequencer to the Nord Lead 2X, which will respond by dumping all its Controller values into the sequencer for recording. The “All Controllers Request” message is described in the MIDI Implementation section.

MIDI SYSEX BULK DUMP

To dump one or more Programs or Performances via MIDI as System Exclusive data, for reprogramming of another Nord Lead 2X or for recording the data into another MIDI device, do like this:

1. Connect a cable from **MIDI OUT** on the Nord Lead 2X to MIDI In on the other device.
2. Set up the receiving device so that it accepts MIDI System Exclusive data.
3. To Dump *Performances*, enter “Performance Mode” (see [page 32](#)). To Dump *Programs* or *Percussion Kits*, make sure you are in Program mode.
4. If you want to transmit one Program/Performance only, select it with the **UP/DOWN** buttons.
5. If needed, set the other device to its “recording mode”. Hold down the **SHIFT** button and press “Dump One” (**OCT SHIFT +**) to transmit the current Program/Performance only or “Dump All” (**OCT SHIFT -**) to transmit all Programs/Performances of the current Bank.

To receive a Bulk Dump, proceed as follows:

1. Connect a cable from MIDI Out on the transmitting device to **MIDI IN** on the Nord Lead 2X.
2. If you are about to receive a complete Bank, you need to scroll to a number in the Bank (Program or Performance Bank) you want to replace with the received Bank.
3. Initiate the transmission on the transmitting device.

If the dump contained a complete Bank, it will take the place of the selected Bank in the Nord Lead 2X. If the dump contained one Program/Performance only, this will be put in the “edit buffer” of the active Slot, instead of the Program/Performance you were playing. However, it is not saved permanently. To save it, use Store as described on [page 23](#) and [page 35](#). **Note that any Percussion Kits in a Performance, will only be included as “references” when you dump the Performance. If you want to dump Percussion Kits including all parameters, you have to be in Program mode!**

11. SYNTHESIS BASICS

INTRODUCTION

Subtractive synthesis is one of the oldest and most widely spread forms of synthesizing sounds. It is the method employed in such classics as the Moog synthesizers, the Sequential Prophet-5 and 10, Arp synthesizers, most Oberheim synthesizers, the Roland Jupiter models, the TB-303 etc; the list is practically endless. Even new digital instruments such as workstations and sample playback devices employ many of the basic principles of subtractive synthesis.

With the first Nord Lead, Clavia introduced a new concept: a modern digital instrument that combined a faithful reproduction of the behaviour of the old analog favourites with the convenience and stability of the newer designs. The Nord Lead 2X takes this concept even further, adding valuable new features and functionality.

The purpose of this chapter is to give you a quick introduction to this world of subtractive synthesis as used in the Nord Lead 2X and its analog predecessors. If you'd like to know more, there are number of text books on the subject.

THE “BUILDING BLOCKS”

Subtractive synthesis started its life in *modular synthesizers*, large cabinets housing separate electronic modules, connected via patch cords. With the advancement of technology, the functionality of many of these modules could be put onto one single circuit board. But functionality-wise, subtractive synthesizers are still built out of the same modules (or building blocks) as they were decades ago.

We will now take a closer look at these building blocks. Let's first talk about the three that actually create and process sound:

OSCILLATOR

The Oscillator is actually the only thing in a synthesizer that actually *produces* any sound, (all the other modules only *shape* the sound from the oscillator.) The oscillator is a bit like the string on a string instrument, it vibrates to create sound.

FILTER

The signal from the oscillator is sent through the Filter which shapes the *timbre* of the sound to make it “bright”, “dull”, “thin”, etc.

AMPLIFIER

The Amplifier shapes the *volume* of the sound making it “soft” or “hard”, “slow” or “short”.

In addition to these major three modules all synthesizers also have “modulators”, devices that can make the volume, timbre pitch and other qualities of sound vary continuously when you play a key. It is these modulators that basically add animation to the sound, taking it from a dull organ drone to a dynamic and interesting timbre. The two most common modulators are Envelopes and LFOs:

ENVELOPES

An envelope is used to give a sound a “shape”. If you apply an envelope to the amplifier (which controls the volume) you are able to make the sound for example slowly fade in and then fade out when you press and hold a key.

LFOs

LFO is an abbreviation for Low Frequency Oscillator. It is used for repeating variations in a sound, such as vibrato or tremolo.

CONNECTIONS

There are many ways in which the modules outlined below can be connected in a synthesizer, but the one in the picture below is a basic and common one, used in the Nord Lead 2X (although the illustration depicts far from all the possibilities in this instrument!)

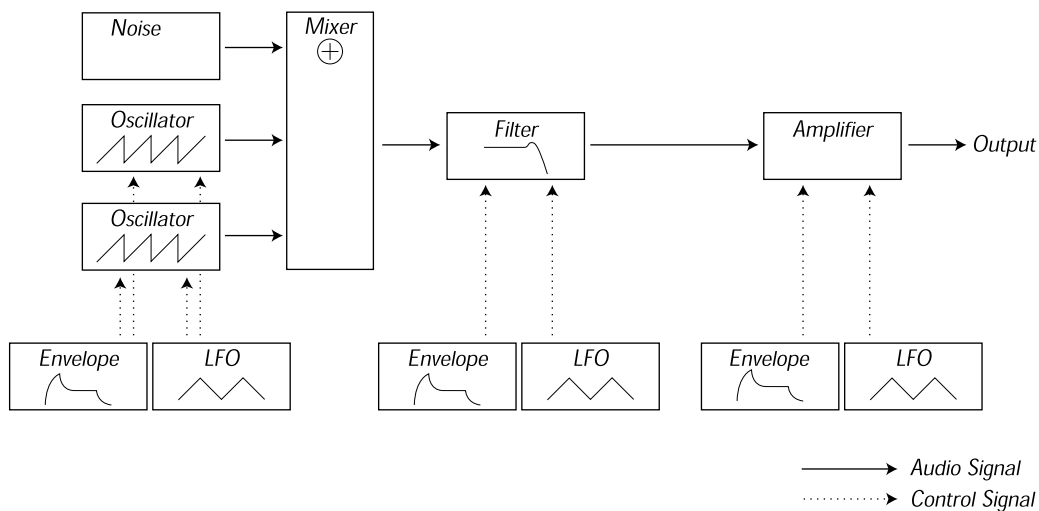

Note that the horizontal lines indicate the way the sound travels. The vertical lines indicate control signals. The envelopes for example only *modulate* (control) the oscillator, filter and amplifiers, they do not affect the sound directly.

THE OSCILLATORS AND WAVEFORMS

The two basic qualities of an oscillator is waveform and pitch.

PITCH

The picture of the sawtooth on the Nord Lead 2X front panel displays a sawtooth during one *period* of sound. During this time, the wave raises gradually up to maximum level and then instantly drops back to minimum level.

The length of the period determines the pitch (frequency) of the sound. The shorter the period, the higher the pitch. If you for example make the oscillator play at a frequency of 440Hz, there will be 440 periods of identical Sawtooth waves generated per second.

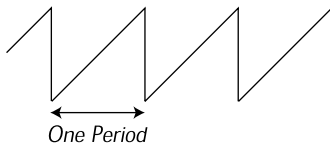

Normally there are three ways to change the frequency of an oscillator:

- **By making settings on the front panel.** On the Nord Lead 2X for example, you have an “Oct Shift” setting for both oscillators and separate Semitone and Fine Tune adjustments for Oscillator 2.
- **By playing the keyboard.** The keyboard is of course connected to the oscillator so that pressing different keys produces different pitches. In some cases this connection can be turned off, so that the oscillator always plays the same pitch, regardless of which key is pressed. In the Nord Lead 2X, this can be done for Oscillator 2, by deactivating “Kbd Track”.
- **By Modulation.** Modulation allows you to make the pitch vary “automatically”. The most common example is probably to use an LFO to make pitch go up and down, to create a vibrato. But you can also put the pitch under envelope control, or make the pitch vary with your striking force (velocity).

WAVEFORM

The waveform of the oscillator affects its harmonic content and thereby its “sound quality” (timbre). The three most common waveforms are sawtooth, pulse wave and triangle.

Looking at the shape of a waveform tells very little about how it sounds. Instead, there’s a better way to draw it, called a *spectrum*. Let’s introduce some quick theory:

Mathematically, all waveforms can be considered as built from a number of *harmonics*, added together.

Each of the harmonics consists of a *sine wave*, the purest and simplest waveform there is (a sine wave has no harmonics at all). In other words, if you add a number of sine waves together, each one with its own pitch (frequency) and volume (amplitude), then you can build any waveform you like.

The lowest harmonic is called the *fundamental*. The fundamental determines the basic pitch of the sound. If the fundamental has a frequency of 440Hz, we will perceive the entire sound as having a pitch of 440Hz.

Other harmonics are then added to the fundamental, called *overtones*. Normally the first overtone appears at a frequency twice the fundamental (in our example 880 Hz). The next harmonic appears at a frequency three times the fundamental (in our example 1320Hz) and so on.

In a spectral display of a waveform you can see the *frequency* (pitch) of each harmonic and its *amplitude* (level). This is done by drawing each harmonic as a line raising up from a horizontal scale.

Each line’s position on this scale indicates the harmonic’s frequency. The line furthest to the left is the fundamental, the next is the first harmonic etc. To make life easier, one usually doesn’t label the horizontal scale with frequency in Hz, but rather with the number of the harmonic.

The height of each line represents the amplitude of each harmonic.

If you understand the principle, you also understand that if the harmonics with high numbers have a high amplitude, the sound will be perceived as bright.

Let's take a look at some common waveforms and their spectra.

In the illustrations below, only some of the first harmonics are displayed. In reality, waveforms like these have an infinite amount of harmonics.

SAWTOOTH

The Sawtooth wave has a simple spectrum. All harmonics are present in the wave, in proportional values. As you can see, the high harmonics have a fairly high amplitude, which makes this waveform sound bright.

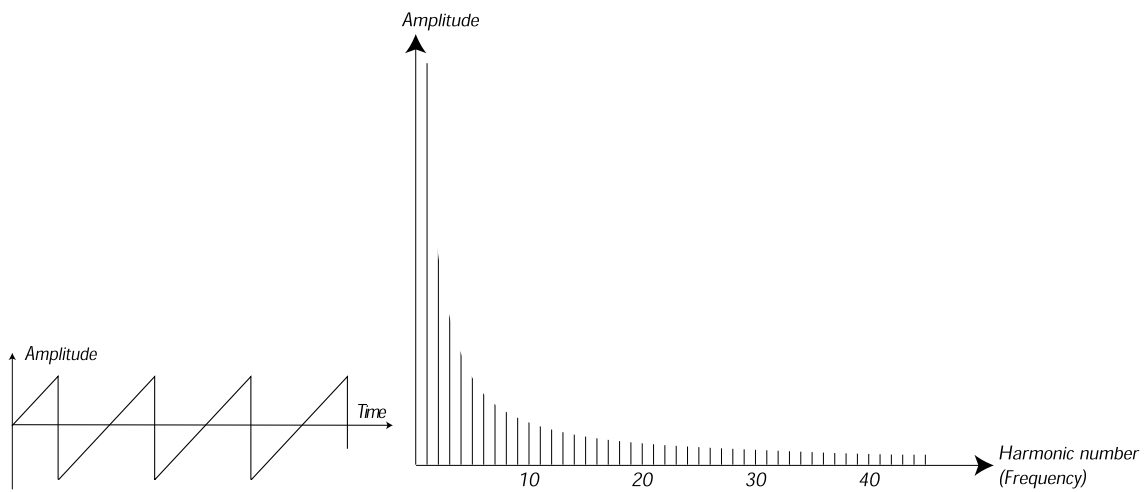

TRIANGLE

The triangle wave does not have very strong harmonics. Furthermore they only appear at odd harmonic numbers. The first fact makes the tone pure, a bit like a flute, and the second fact gives the sound a slightly "hollow" character.

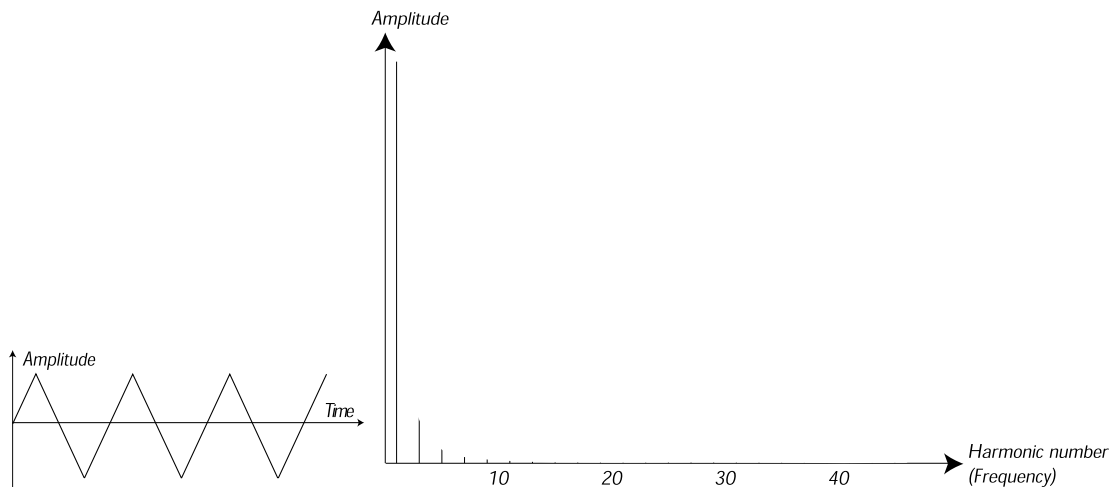

PULSE WAVE

The pulse wave is slightly more complicated, because it is not *one* waveform, it is many different ones. A pulse wave is a waveform that during one period jumps once between full positive amplitude and full negative and then back. The thing that can be varied is *where* within the period you jump from maximum to minimum amplitude. Let's look at three examples:

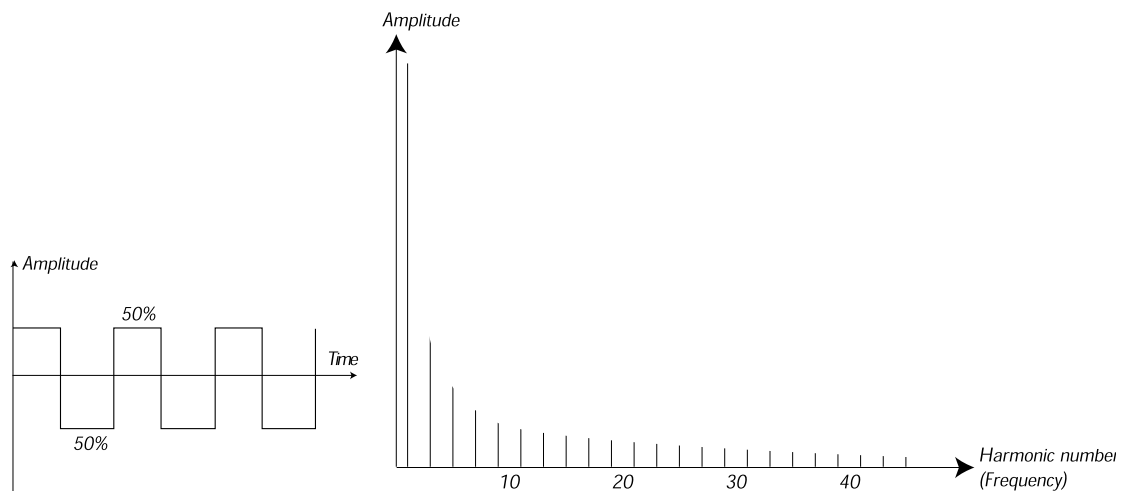
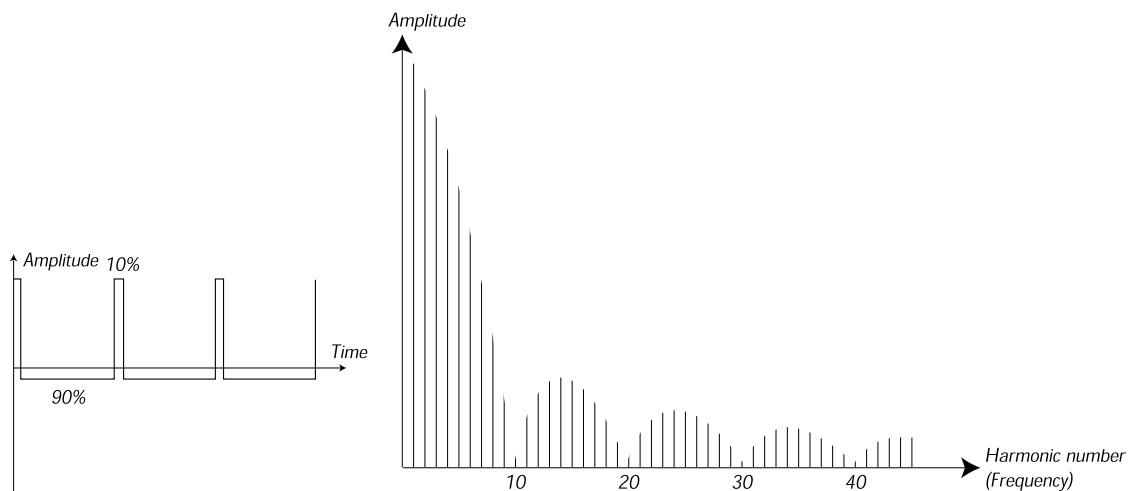
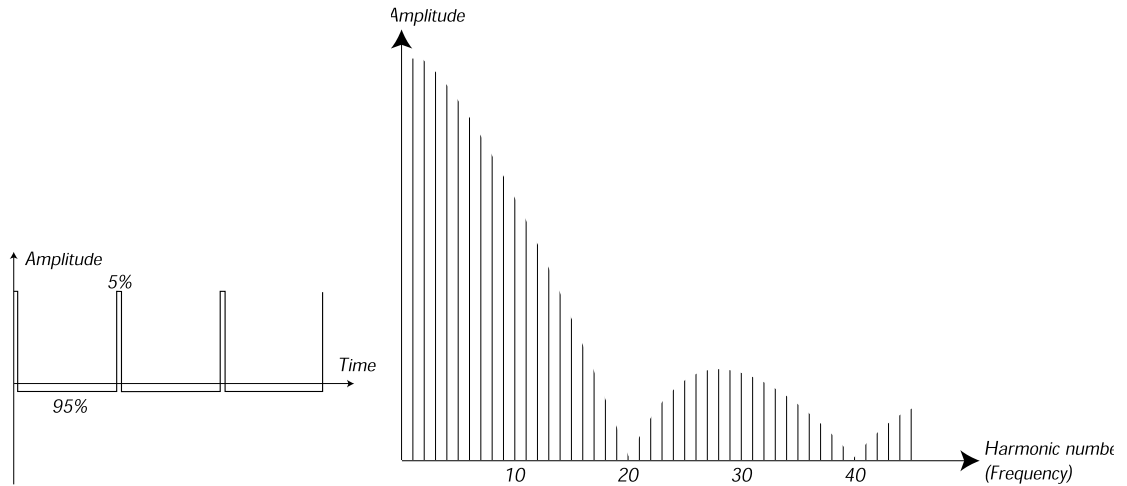

In the first, the jump happens 5% in from the beginning of the period. This is referred to as a pulse wave with a 5% *pulse width* (sometimes called *duty cycle*). The second wave has a pulse width of 10%. The third wave has a pulse width of 50%.

This third wave is a special case of the pulse wave, called a *square wave*, and this has one peculiarity, it only contains odd number harmonics, which gives it a “hollow” quality.

On many synthesizers (including the Nord Lead) the pulse width can be adjusted, to set the timbre of the pulse wave. The more narrow the pulse width, the more “thin” the sound will be.

You can also have the pulse width vary continuously, for example from an LFO or envelope. This is referred to as *pulse width modulation*. Modulating pulse widths from an LFO creates a rich, chorus-like effect often used in “string” sounds.

ABOUT INHARMONIC SPECTRA

Above we have only discussed spectra where the overtones appear at perfect harmonics. While this is true for the basic waveforms discussed above, it is definitely not true for all sound. If you for example use the frequency modulation (FM) or Ring Modulation capabilities in the Nord Lead 2X, with the two oscillators set to an “unusual” interval (not octaves or fifths, for example), you will get a spectrum where the overtones appear at frequencies somewhere *between* the perfect harmonics. This results in an *inharmonic* sound, which often sounds “metallic”.

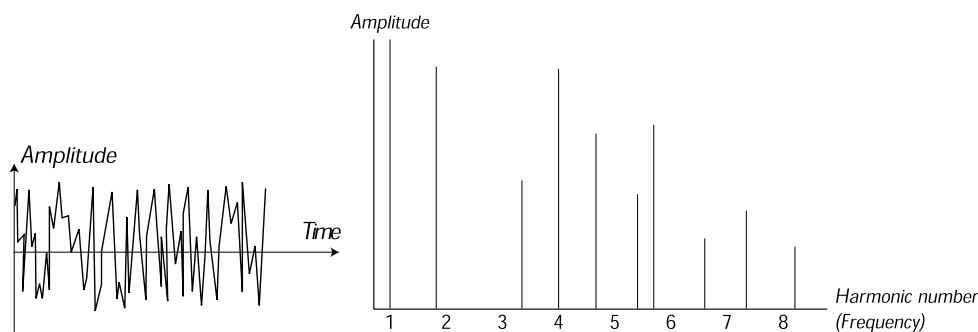

SYNC

On some instruments (including the Nord Lead 2X), two Oscillators can be *synchronized*. If you for example synchronize Oscillator 2 to Oscillator 1, Oscillator 2 will start over with a new period of the waveform, each time Oscillator 1 does so. If Oscillator 2 then has a higher frequency than 1, it will get a complex waveform that depends both on its own pitch and on that of the other oscillator.

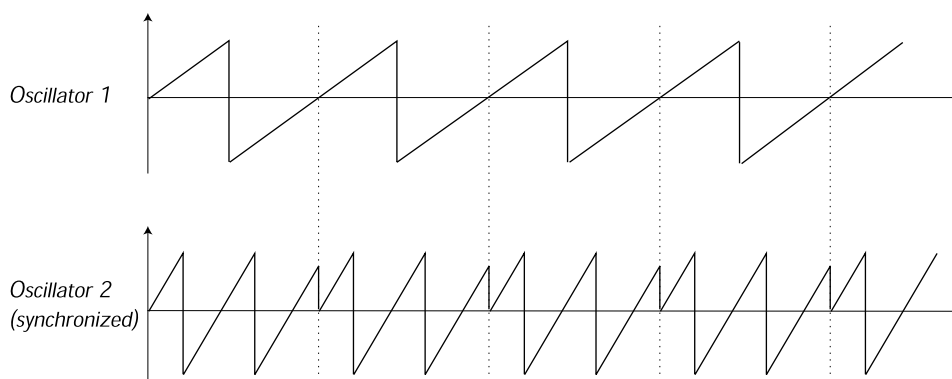

When sync is applied, the basic pitch of Oscillator 2 is locked to that of Oscillator 1. If you change the pitch of Oscillator 1 you will affect the basic pitch of both oscillators. Furthermore, when you vary the pitch of the synchronized oscillator (Oscillator 2), this will be perceived as a change in timbre, rather than in pitch.

This leads to a spectrum with deep resonances at Osc2's harmonics, like this:

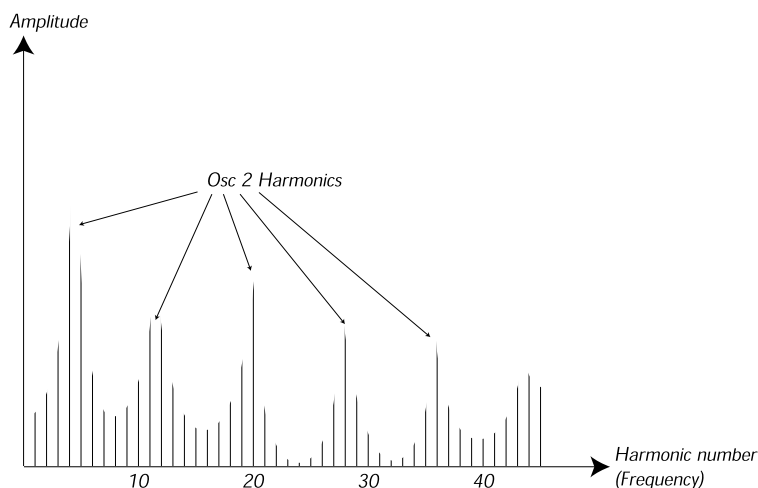

If you go even further and let the pitch of the synchronized oscillator vary continuously, for example from an LFO or envelope, you will change the harmonic content of the sound in an interesting and very characteristic way.

THE FILTER

The filter in a synthesizer is used to remove or emphasize frequencies in a spectrum. A filter is a bit like an amplifier (a volume control) that is applied differently to different parts of the spectrum. For example, a filter might make low frequencies louder, while at the same time making high frequencies weaker. Applying such a filter would make a sound have more bass and less treble.

Let's imagine a sound with a spectrum where all harmonics are available at full level. It would look like this:

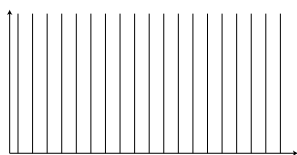

Let's now pass this spectrum through a *lowpass* filter (this type of filter is discussed in more detail below). The filter has a characteristic, which can be drawn as a curve.

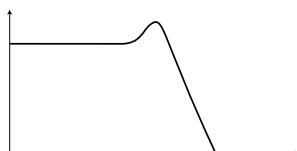

As you can see the curve is flat in the low register (which means it doesn't affect this part of the spectrum at all) and then, at a certain point, gradually starts falling. When applied to the wave above, this filter cuts away some of the high frequency material in the wave, like this:

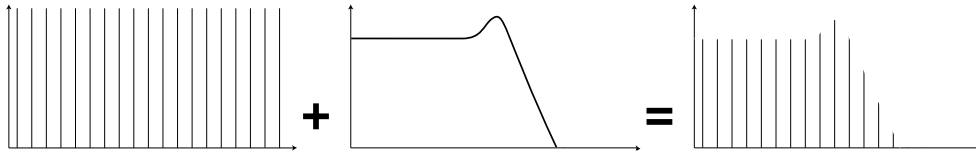

FILTER TYPES

There are many types of filters, all with their different purposes. We will here discuss the three most common, the ones found in the Nord Lead 2X.

LOWPASS FILTER

The Lowpass filter dampens high frequencies and let's low frequencies pass through unaffected, as in the example above. It is the most common synthesizer filter, since it can be used to "round off" the sharp sound of sawtooth waves and pulse waves.

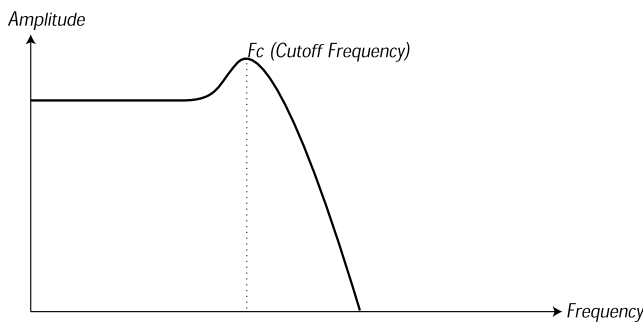

HIGHPASS FILTER

This is the opposite of the lowpass filter. It let's the high frequencies of the sound pass through and cuts off the low frequencies. This removes "bass" from a sound, without affecting the high end.

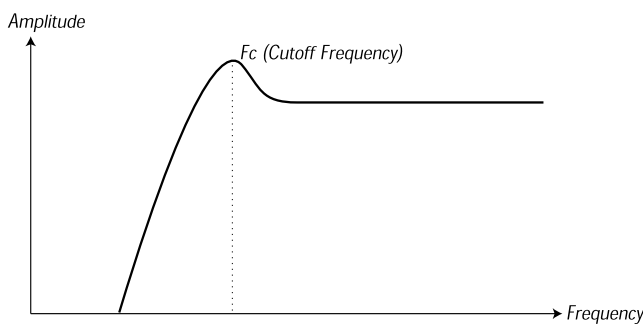

BANDPASS FILTER

This let's frequencies in a certain range of the spectrum (the band) pass through while dampening frequencies both below and above this range. This accentuates the mid-range of a sound.

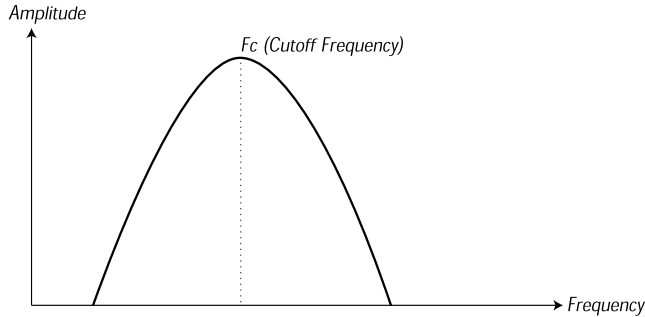

NOTCH FILTER

This filter type (also known as Band Reject) can be seen as the opposite of a band pass filter. It cuts off frequencies in a “mid-range” band, letting the frequencies below and above through.

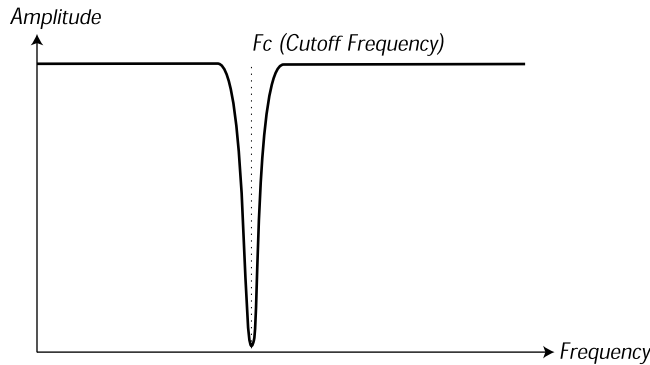

In the Nord Lead 2X the Notch filter is combined with a 12 dB Lowpass filter, for greater musical versatility (see [page 49](#)).

ROLL-OFF

Filters of one and the same type (lowpass, highpass etc) can have different characteristics. One of the factors determining the exact filter curve is the *roll-off*, which is measured in *dB/Octave* (“decibels per octave”) or *poles*. The simplest possible filter has a roll-off of 6dB/octave, which is referred to as “1 pole”. The next step up is 12dB (2 poles), 18db (3 poles) etc.

The most common synth filters are the 12dB and 24dB lowpass filters. The difference between the two can be studied in the graph below. The 12dB filter let's more of the high frequency pass through which gives the sound a brighter and “buzzier” character than the 24dB filter does.

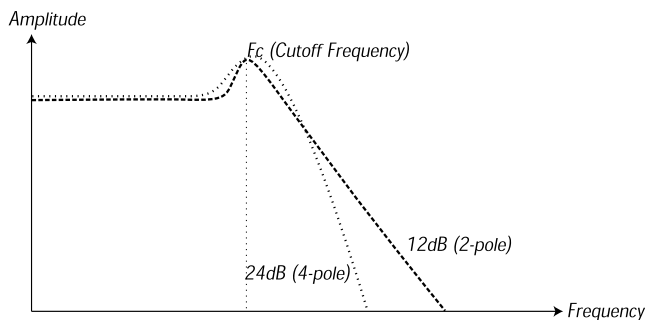

In the Nord Lead 2X, the lowpass filter can be switched between 12 and 24dB modes. For sounds with high resonance (see below), similar to those in the Roland TB-303, we recommend the 12dB variation. For most other sounds we recommend 24dB.

CUTOFF FREQUENCY

The most important parameter for a filter is its *cutoff frequency*, which is the setting that determines *where* in the frequency material it should start cutting. If the cutoff frequency in a low pass filter is set to a very low value, only the lowest harmonics (the bass) will pass through. If you raise the cutoff all the way up, *all* frequencies will be let through, as the figure below illustrates.

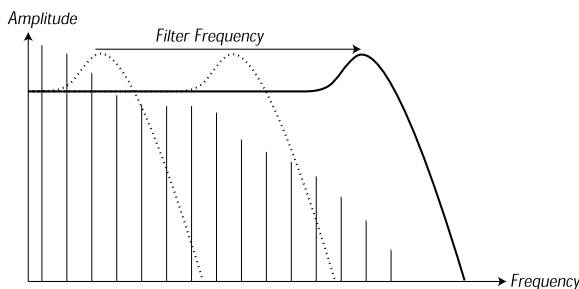

Changing the cutoff frequency is often referred to as “sweeping the filter”. This is probably one of the most important ways of shaping the timbre of a synthesizer sound. By using an envelope you can for example have a high cutoff at the beginning of a sound which is then gradually lowered (the filter “closes” as the sound decays). This would emulate the way most plucked string sound (piano, guitar etc) behave; the amplitude of the harmonics decreases as the sound decays.

KEYBOARD TRACKING

When you play different pitches, the oscillators produce different frequencies. This means that the overtones in the waveform appear at different frequencies. The cutoff frequency of the *filter* however, is fixed. This means that different overtones will be cut off at different pitches. To be more precise, the further up the keyboard you play, the muddier the sound will be.

To remedy this problem many synthesizers have a parameter called *Filter Keyboard Tracking*. When this is activated, the filter Cutoff Frequency varies with which key you play, just as the oscillator frequency does. This ensures a constant harmonic spectrum for all keys.

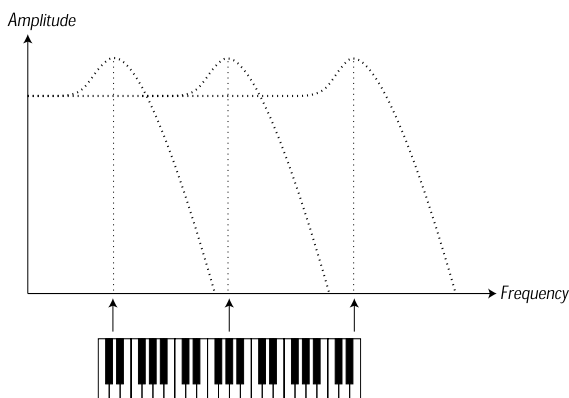

RESONANCE

Resonance in a filter is created by connecting the output of the filter to its input, in other words setting up a “feedback loop”. The amount of feedback is then controlled with a Resonance parameter on the front panel of the instrument.

When you apply resonance, the frequencies just around the cutoff point of the filter will be emphasized (louder). As you increase the Resonance further and further, the filter will start to behave more and more like a bandpass filter, where only the frequencies around the cutoff point are let through. The filter will start to “ring”, which means it almost sounds like it is *adding* frequencies to the sound. If the Resonance is then raised even further (on some synthesizers) the filter will start to self-oscillate, that is produce sound of its own, just like an oscillator.

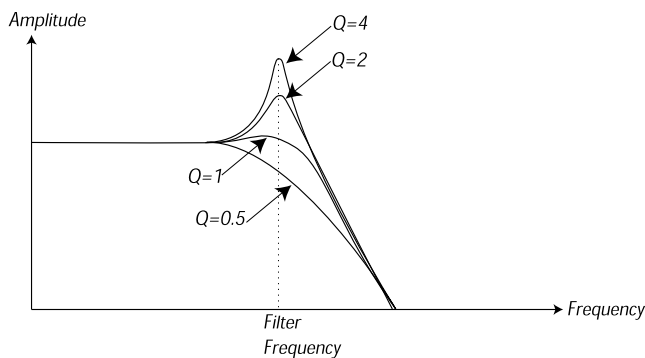

High Resonance values are also visible in the waveform. They appear as a “superimposed” waveform with a frequency equivalent to the filter’s cutoff frequency. The three examples above show the same wave with increased resonance.

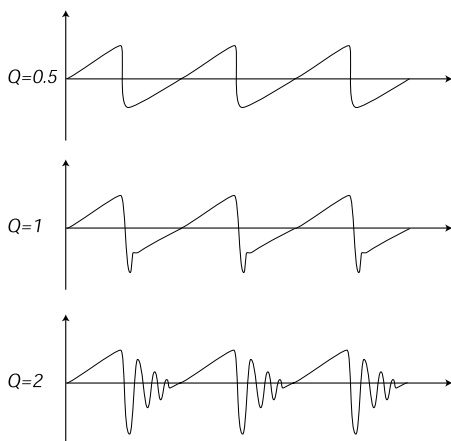

If you add Resonance to a sound and then vary the Cutoff frequency (for example with an envelope) you will get a very typical synthesizer sound.

THE AMPLIFIER

An amplifier is most often used at the final stage of a synth signal chain, to control volume. By modulating the amplifier with an envelope, the sound can be given its basic “shape”. In fact, the “volume shape” is one of the most important factors to how we identify the sound. By setting up a proper volume envelope you can make a sound “soft”, “hard”, “plucked” “static” etc.

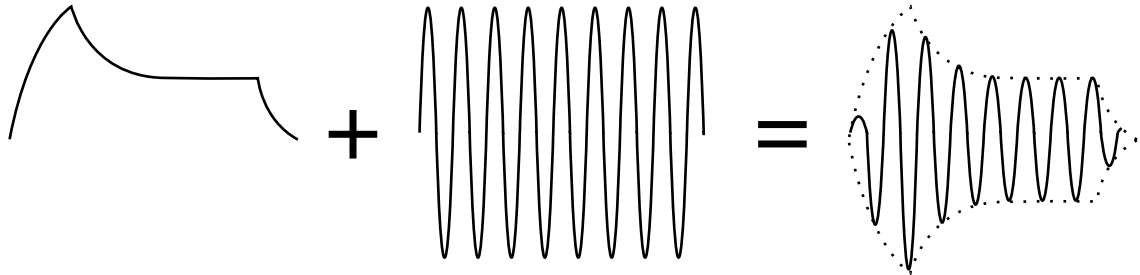

The volume envelope curve (to the left) determines how the amplitude of the waveform changes over time.

ENVELOPES

ADSR-ENVELOPE

Envelopes are used to modulate pitch, amplitude, filter cutoff and other parameters in a sound. This is used to give the sound a varying character from the moment the key is pressed to the moment it is released.

The classic synthesizer envelope has four parameters, Attack, Decay, Sustain and Release, and is therefore often referred to as an “ADSR-envelope”.

When you press a key, the envelope is *triggered*. This means it starts rising from zero to maximum level. How long this should take, depends on the *Attack* setting. If the Attack time is set to “0”, the envelope will instantly reach full level. If it is raised it will take longer.

If you for example have an envelope controlling volume, raising the attack will give the sound a “softer” character. If you have the envelope routed to the filter, it might give the sound a “wah” type of start.

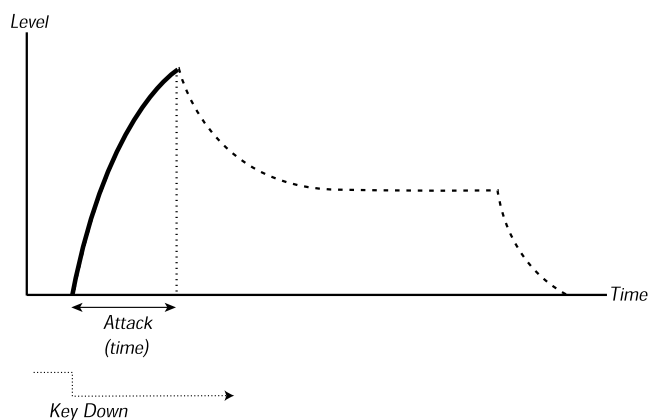

After the envelope has reached full level, it starts to fall back again. How long this should take, is set with the *Decay* parameter.

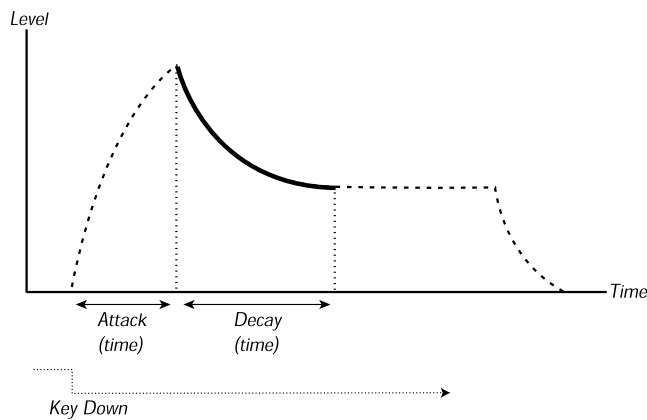

The level of the envelope does not necessarily have to fall all the way back to zero level at the end of the Decay. Instead, the ADSR-envelope has a *Sustain* setting used to determine the level the envelope should rest at, after the Decay. If you for example want to create a flute sound, you would have a fairly high Sustain setting on your Volume envelope, since a flute tone basically stays at a steady level for as long as you play it. On the other hand, for a piano sound, you would want a Sustain level of "0", since a piano sound decays to silence if you hold the key long enough.

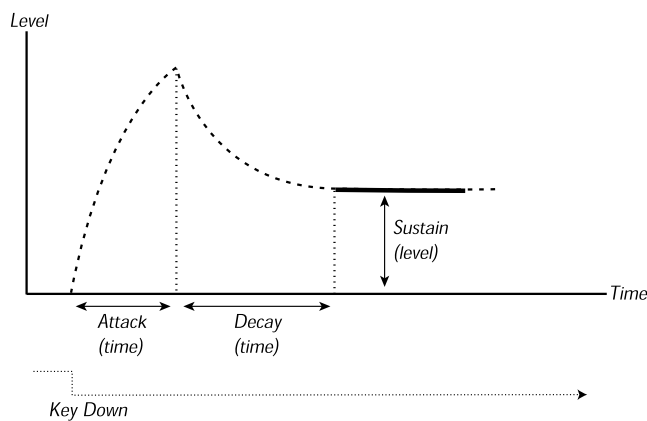

Please note that the Sustain parameter represents a *level*, but all other envelope parameters represent *times*.

As described above, the envelope stays at the Sustain level until the key is released. It then falls back to zero level. The time it should take for this to happen is set with the *Release* parameter, which works just as the Decay, only it is not applied until you lift your finger off the keys.

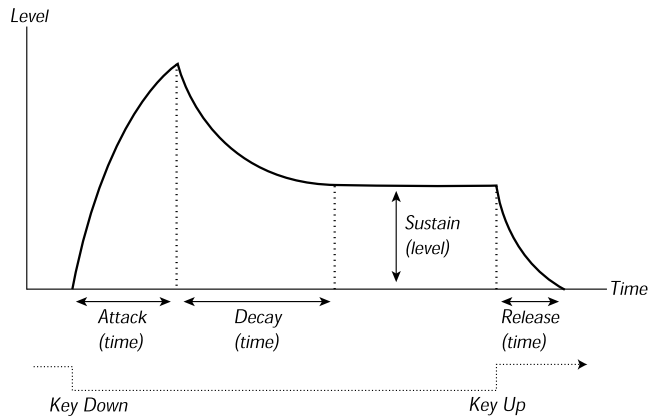

- If you set Sustain to full level, the Decay setting is of no importance since the volume of the sound is never lowered:

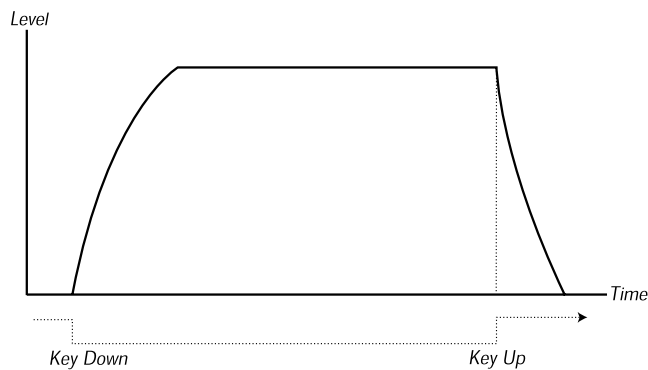

- If you set Sustain to 0, the sound will become silent after the Decay phase is finished. With short Attacks moderate Decay times, this can be used to simulate the behaviour of a plucked string instrument (guitar, piano etc) where the sound always decays to silence after a while:

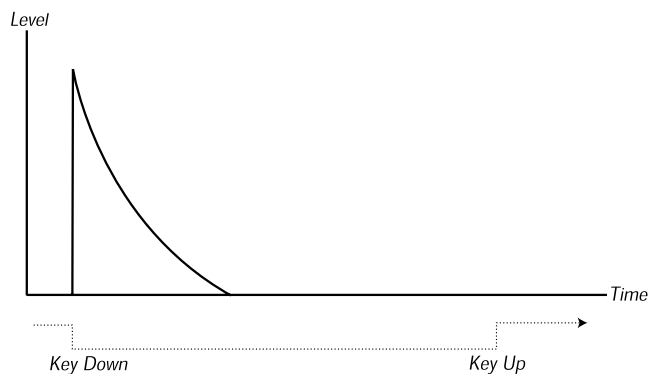

- If you release a key before the envelope has reach its sustain, it will immediately “jump” to the Release. The effect of this can be studied in the illustration below:

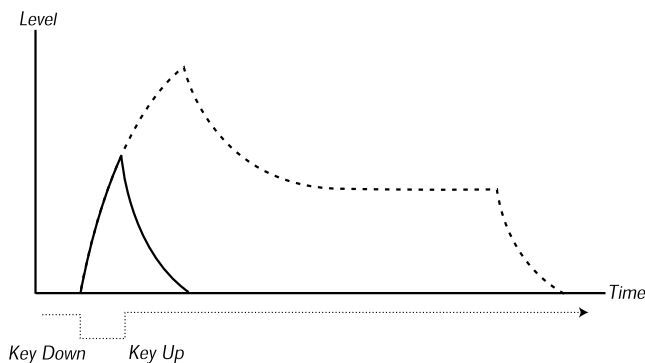

Often envelope levels can be made to vary with how hard you play the keys. This is used to make a sound vary with your playing style, for example to make the sound brighter (filter envelope) or louder (amplifier envelope).

AD-ENVELOPE

A simpler form of envelope has Attack and Decay parameters only, and is therefore called an AD-envelope. In effect, the AD-envelope behaves like an ADSR-envelope with Sustain set to 0 (see the picture at the top of this page). This type of envelope, often with amount and inversion controls, is suitable when you want to affect the start of the sound only.

On the Nord Lead 2X, the Modulation Envelope is of AD-type. Typically, it can be made to modulate the FM amplitude or the pitch of Oscillator 2, to create a different timbre during the attack part of the sounds.

LFOs

An LFO is an oscillator, just like the ones that produce the sound in a synthesizer, but with two main differences:

- The LFO produces very low frequencies, most often below the hearing range (up to 20Hz).
- The LFO is not used to produce sound, instead it is connected to other modules to provide modulation of parameters. If you for example route an LFO to pitch, you get a vibrato. If you route it to the filter's cutoff frequency you get a wah-wah type of effect. And if you route it to the amplifier of an instrument you get a tremolo.

The three basic parameters for an LFO are *Waveform*, *Rate* (frequency) and *Amount*:

- The waveform determines the type of vibrato, for example “regular” (triangle or sine), ramp (sawtooth) or random.
- The Rate determines the speed of the vibrato.
- The Amount controls to what degree the LFO affects its destination.

12. FACTORY PRESETS

PROGRAM BANKS 0-3

BANK 0 (RAM)

Prg	Name	Prg	Name	Prg	Name
1	Clearly for Techno	34	Picked Bass	67	Poppy SQU Synth
2	And God made Resonance	35	Funk FM Bass	68	VEL Soundtrack
3	Delay Synth Brass	36	FM Bass	69	Glass Voices
4	Dark Stereo Pad	37	Spike Bass	70	Plucky Pad
5	Dark DUB Bass	38	Smooth Bass	71	Velo REZO
6	The MadMan Reso Synth	39	Flimsy Bass	72	Slow Swello
7	Vibe Bell	40	FM FunKeys	73	Introspection Pad
8	Skywalker 1	41	Techno Synth 1	74	Funky Talk
9	Deep Purple	42	Techno Synth 2	75	Filtered Strings
10	Trekker	43	Scritti Plucky	76	Smooth Pad
11	Flange gtr.	44	Velo Comp Synth	77	CyberFunk Clav
12	Billibass	45	SAW Keys	78	Angel Pad
13	Tuned Resonance Pad 1	46	SEQ Pulse Synth 1	79	Chime Pad
14	Stereo Perk Pad	47	Talking REZ	80	The Calling
15	Clearly the Bell	48	Rodney J SAWS	81	Synth Rise
16	ResoRoto	49	SEQ Pulse Synth 2	82	Stardust FM
17	LFO Squares	50	Synth Brass Section	83	Metallic Synth
18	Arpeggiate Me!	51	Dirty SAW Techno	84	Rude SQU
19	Teddy's Talkbox	52	Hi-Pass VEL Synth	85	Drama Pad
20	VEL Rez Bass	53	Synth Comp Pluck	86	SQU Lite
21	D&B Bass	54	Old School Synth	87	Subtle Pad
22	VEL Fuzz Bass	55	Rising REZ Pad	88	Dramatic Sweep
23	One Or One Bass	56	Techno SAW Comp	89	Vinyl Opera
24	DRE Bass (use wheel)	57	Heavy REZ	90	IV DisCHORD Pad
25	Dodger Bass	58	Funky Pick	91	Mini Lead 1
26	Funk REZ Bass	59	Legato REZ	92	Funk REZ Lead
27	TRI REZ Bass	60	Velocity SAW	93	TRI VEL Lead
28	U Know Bass	61	RAVE synth	94	REZ Mini Lead
29	SQU VEL Rez Bass	62	Stevie's Comp	95	Mini Lead 2
30	SAW REZ Bass	63	Phase Synth	96	Mini Lead 3
31	2 Step Bass	64	Old School Synth 2	97	Synce'd Up!
32	Punctuating Bass	65	PWM Clav	98	Cutting Edge Saws
33	Low End	66	SEQ Polysynth	99	Organesque

BANK 1 (RAM)

Prg	Name	Prg	Name	Prg	Name
1.1	Sawbrass	1.34	String pad	1.67	Acid 2
1.2	Velocity strings	1.35	Solo pulse	1.68	legato bass
1.3	Resonance pad	1.36	Space pad	1.69	Black Hole
1.4	Hard string pad	1.37	Sample/hold	1.70	Sub
1.5	Resonance fade pad	1.38	Saw legato solo	1.71	DB
1.6	Portamento quints	1.39	Echo sound	1.72	Widebody
1.7	A fifth pad	1.40	Pulse solo	1.73	Fluff
1.8	Pulse pad with FM	1.41	Soft strings2	1.74	Steeldrums
1.9	Weather bass	1.42	Majesty	1.75	Wurz piano
1.10	Lead saw solo	1.43	Glass brass	1.76	My Clav
1.11	Soft saw lead	1.44	Gimme 5	1.77	1 bow
1.12	Zyntar	1.45	Flute choir	1.78	Tack clav
1.13	Arpeggiator down	1.46	Brass Comp	1.79	Span Eyes
1.14	FM Metallic	1.47	Sync sweep	1.80	Floote
1.15	Attack bass	1.48	Synth strings	1.81	Hampflafon
1.16	Saw mono	1.49	Trumpets	1.82	Thumpinet
1.17	Osc 2 modulation	1.50	Duke	1.83	Bell bar
1.18	Guitar 1	1.51	Dirty FM	1.84	Flageolettes
1.19	Violin	1.52	Space clavinet	1.85	Rotator
1.20	Source bass	1.53	Resonant saw	1.86	Tuba
1.21	Perc Lead	1.54	FM lead	1.87	Trumpet
1.22	FM Clavinet	1.55	Talking clavinet	1.88	English horn
1.23	Soft strings	1.56	Saw ring	1.89	Metal Flute
1.24	S/H techno	1.57	Eraser	1.90	Voice
1.25	Resonance sweep	1.58	Take the fifth	1.91	FM horn
1.26	Phaser	1.59	Echo pad	1.92	Harpsichord
1.27	Brite pad	1.60	Yeow!	1.93	Electric piano 2
1.28	Analog grand	1.61	Syncher	1.94	Musing
1.29	Electric piano 1	1.62	Low bass	1.95	Chang
1.30	Random Arpeggio	1.63	water bass	1.96	Ravi
1.31	Clarinet	1.64	Pick bass	1.97	Guess!
1.32	Didjeridu	1.65	FM morph bass	1.98	Tubular
1.33	Sax	1.66	Acid 1	1.99	Waterhall

BANK 2 (RAM)

Prg	Name	Prg	Name	Prg	Name
2.1	Polysynth 1	2.34	Probrass	2.67	Wave Bell
2.2	Polysynth 2	2.35	D-tune Brass	2.68	Sunrise
2.3	Polysynth 3	2.36	Wetbrass	2.69	Organ/e.piano
2.4	Ambient poly	2.37	Creambrass	2.70	Euro Lead
2.5	Human League 1	2.38	Softbrass	2.71	Sytar
2.6	Human League 2	2.39	Pulsebrass	2.72	Percstrings
2.7	Wet poly	2.40	Human Rez	2.73	Woodo
2.8	Fat poly	2.41	Rez Pluck	2.74	Tremolosynth
2.9	Legatobass	2.42	Amb Sine Pluck	2.75	Hitech
2.10	Infinite bass	2.43	Yazoo	2.76	Talkbass
2.11	Ratata bass	2.44	Yazpiano	2.77	Hipass303
2.12	Rubber bass	2.45	Depe Che Pluck	2.78	Bandpass303
2.13	Click bass	2.46	Pulse Pluck	2.79	Hitech 2
2.14	Sawbass	2.47	Pulse Shimmer	2.80	Tube
2.15	Sawbass oct	2.48	Seq Pluck	2.81	Dist Git1 - wheel
2.16	Phatbass	2.49	Pulse Pluck 2	2.82	Dist Git3 - wheel
2.17	FMbass	2.50	Slow Pad	2.83	Dist Git3
2.18	Knockbass	2.51	Soft Pad	2.84	Monsterbass
2.19	Tightbass	2.52	Sine Pad	2.85	Organ 1
2.20	Electricpiano 1	2.53	Massive Pad	2.86	Organ 2
2.21	Electricpiano 2	2.54	Organ Pad	2.87	Organ 3
2.22	Electricpiano 3	2.55	Brite Pad	2.88	Radio Days
2.23	Knockwurlitzer	2.56	LFO Pad	2.89	Moonsong
2.24	Bellpiano	2.57	Octpad	2.90	Lasergun
2.25	EPsmack	2.58	Gentle Pad	2.91	Space
2.26	Synclav	2.59	Sitarpad	2.92	Bird
2.27	Thinclav	2.60	Digibell 1	2.93	Flipstring
2.28	FMclav	2.61	Digibell 2	2.94	Cyber
2.29	Vibroclav	2.62	Crysister	2.95	Cybertalk
2.30	Polybrass	2.63	LFO Bell	2.96	Cyberspace
2.31	Pulsebrass	2.64	Crisp Bell	2.97	Plipp/plopp
2.32	Wetbrass	2.65	Basseverb	2.98	Darthvador
2.33	JX8P stab brass	2.66	Gentle Bell	2.99	Rain

BANK 3 (RAM)

Prg	Name	Prg	Name	Prg	Name
3.1	Big Bell	3.34	Wind	3.67	Quick Lead
3.2	Arpeggibass	3.35	Juicy Arpeggi	3.68	Swept Fifth Arp
3.3	Breathy Attack	3.36	Rolling Phase Lead	3.69	Rubber Arp
3.4	Organ	3.37	Weel Tempo Arpeggi	3.70	Rubber Arp Iii
3.5	Shimmering	3.38	Velzabpass	3.71	Eurhythmic Reverb
3.6	Six Wives	3.39	Classic Analog Horn	3.72	Lunar Arp
3.7	Kick/snare	3.40	Water Drops	3.73	Vapour Spaced I
3.8	Heartbeat	3.41	Morphsong	3.74	Vapour Spaced Ii
3.9	Bouncing Glassball	3.42	Electro Lace	3.75	Illusionary Arp
3.10	Electrocution	3.43	Classic Buzz	3.76	Vangellic Arp
3.11	Noise Percussion	3.44	Phoghorn	3.77	Hojo Arp
3.12	Square Throb	3.45	Voicy Melody	3.78	Veloso Bass
3.13	Glass Sitar	3.46	Lava Q Lead	3.79	Taurus Pedals
3.14	Synth Swirl	3.47	Mr. Floyd Rez Sweep	3.80	Dumb Bass/kick
3.15	Metalglass	3.48	Dist Lead	3.81	Vibrobrass
3.16	Bowed Metalglass	3.49	Mini Hard Lead	3.82	Ow Wheel Bass
3.17	Pulsearpeggi	3.50	Lucky Lead	3.83	Go Ahead London
3.18	Weelsong	3.51	Electrodrone-a	3.84	Poltergeist
3.19	Spacebubbles	3.52	Bandpass Polysynth	3.85	Echolocation
3.20	Velpulse	3.53	Toto Soft Brass	3.86	Antarctica
3.21	Velsaw	3.54	Resonant Bass	3.87	Nine Inch Noise
3.22	Anahorn	3.55	Fatass Brass	3.88	Lo Detune I
3.23	Velocity Arp Rate	3.56	Carousel	3.89	Lo Detune Ii
3.24	Big Bass	3.57	Brassalorg	3.90	Geiger Counter
3.25	Electropanic	3.58	Ob Genevise	3.91	Industrial Drone
3.26	Flutedistmorpher	3.59	Chick Full Of Fifths	3.92	Rewind
3.27	Voxpiano	3.60	Funkin Epiano	3.93	Weed Eater
3.28	Warm Pad	3.61	Stinger Lead	3.94	Radio Breakup
3.29	Organ 2	3.62	Accordion	3.95	Deep Woods Off
3.30	Flutearpeggi	3.63	Bag Pipes	3.96	Cell Phone
3.31	Fat Arpeggi	3.64	Bent Bells	3.97	Hover
3.32	Triangle Morpher	3.65	Lucy	3.98	Be Careful With That N
3.33	Arpeggiklang	3.66	Whistle Buzz	3.99	Birdsong

PROGRAM BANKS 4-7

BANK 4 (ROM)

Prg	Name	Prg	Name	Prg	Name
4.1	Jazz Guitar	4.34	Banana Rama Bass	4.67	Power Chords
4.2	Chick's Lead	4.35	Syn Bass#6	4.68	Stereo Star Cycle
4.3	Jan Lead	4.36	Syn Bass#7	4.69	Accordian
4.4	Star Cycle Lead	4.37	Syn Bass#8	4.70	Glassy Pad
4.5	Farfisa 1	4.38	Syn Bass#9	4.71	Octave Pad
4.6	Sawtooth Mono Lead	4.39	Syn Bass#10	4.72	Frankenstein 2
4.7	Lyle	4.40	Upright Bass	4.73	Scoop Pad
4.8	Way Lead	4.41	Clav#1	4.74	Ancient Mystery
4.9	Whistle	4.42	Clav#2	4.75	Jan Chords
4.10	Wet Glide	4.43	Wurlitzer	4.76	Jump
4.11	Sweep Lead	4.44	Separate Ways	4.77	Stereo Bells
4.12	Chick 4 Ths	4.45	Syn Brass#1	4.78	Ow Pad
4.13	Odd Couple	4.46	Brite Pad	4.79	Electric Parade
4.14	Brassy Wah	4.47	Dark Pad	4.80	Gliding 5ths
4.15	Jan Pulse Lead	4.48	Syn Brass#2	4.81	Stereo Bow Bass
4.16	Schuman Lead	4.49	Harpsichord	4.82	Stereo Syn Bass#1
4.17	Koto	4.50	Analog Voices	4.83	Stereo Gap Bass
4.18	Music Box	4.51	Saxophon	4.84	Stereo Mid Bass
4.19	Zawinul Lead	4.52	Electrosax	4.85	Stereo Syn Bass#2
4.20	Scary	4.53	Elcello	4.86	Stereo Syn Bass#3
4.21	Syn Bass #1	4.54	Farfisa 2	4.87	Stereo Syn Bass#4
4.22	Syn Bass #2	4.55	Frankenstein 1	4.88	Stereo Syn Bass#5
4.23	Syn Bass #3	4.56	Church Organ Flute	4.89	Stereo Star Cycle
4.24	Stevie Bass	4.57	Syn Brass	4.90	Wah Wah Pad
4.25	Dull Bass	4.58	Brassy Pad	4.91	Indescribable
4.26	Syn Bass #4	4.59	Dark Pad	4.92	Marimba/vibes
4.27	Scratch Morph	4.60	Voice Pad	4.93	Omnious
4.28	How Will I Know?	4.61	Square Pad	4.94	Syn Sax Section
4.29	Chameleon	4.62	Vibro Pluck	4.95	Vibro Bass
4.30	Gap Bass	4.63	Dreamy	4.96	Chorousyn Syn Clav
4.31	Pick Bass	4.64	Harp	4.97	Church Organ
4.32	Syn Bass #5	4.65	Pulse Guitar	4.98	Serious Clk Bass
4.33	Octave Mid Bass	4.66	Pluck Pad	4.99	Steel Drums

BANK 5 (ROM)

Prg	Name	Prg	Name	Prg	Name
5.1	Warm Pad	5.34	Wandering Sync	5.67	Hickup Organ
5.2	Pastoral	5.35	Sweller	5.68	Sync Organ
5.3	Mellow	5.36	Love String	5.69	Voco
5.4	Tremelopad	5.37	Unstable	5.70	Thin String
5.5	Velopad	5.38	P String	5.71	Double Attack Cello
5.6	Metalophon	5.39	Square Sweep	5.72	Pwm Arco
5.7	Syncwave	5.40	Hi Velo Sweep	5.73	Wheel Cello
5.8	Velodream	5.41	Velotremulator	5.74	Please Stop
5.9	Portamento Pad	5.42	Blue Lylac	5.75	Amb Zitar
5.10	Bpf Pad	5.43	Slow Horn	5.76	Dx7
5.11	Hpf String	5.44	Subdued Brass	5.77	Noise Ball
5.12	Tri Arp Pad	5.45	Bpf Strings	5.78	Tick
5.13	Soft Fm	5.46	Sine Pad	5.79	Chirp
5.14	Moving Texture	5.47	Koto	5.80	Noisy Metal
5.15	Hpf Sweep	5.48	Woodblock	5.81	Snap Attack
5.16	Slow Warm	5.49	Harp	5.82	Sq Click
5.17	Wah Pad	5.50	Space Wave	5.83	Tri Vel Click
5.18	Laser Harp 1	5.51	Fat Clav	5.84	Cowbell
5.19	Laser Harp 2	5.52	Octave Clav	5.85	Hi Irregular
5.20	Bpf Wah Pad	5.53	Bpf Clav	5.86	Rez
5.21	Mute Jazz Gt	5.54	Fm Clav	5.87	Snap Strung Fm
5.22	The Thumb	5.55	Hollow Fm Ep	5.88	Scif Snap
5.23	High Wahpluck	5.56	Musette In F	5.89	Tight Lips
5.24	Analog Grand 1	5.57	Fm Clav2	5.90	Thin Tin
5.25	Analog Grand 2	5.58	Wah Clav	5.91	Pulse 5th
5.26	Analog Grand 3	5.59	Veloclav	5.92	Det.saw
5.27	Tinder	5.60	Sticky Clav	5.93	Wheel Pw
5.28	Feedback Dist	5.61	Analog Clav	5.94	Octave Tri
5.29	Fm Acoustic	5.62	12 String Clav	5.95	China
5.30	Dirtdlead	5.63	Square Piano	5.96	Dx7 2
5.31	Jazz Git 2	5.64	Nasty Drawbar	5.97	Home Organ
5.32	Fonky Fm	5.65	Tine Ep	5.98	Metal Voice
5.33	Hpf Pluck	5.66	Raw Clav	5.99	Steel

BANK 6 (ROM)

Prg	Name	Prg	Name	Prg	Name
6.1	Unison Velo	6.34	Velo Pulse	6.67	Nerd Sync
6.2	Flat Clic	6.35	Hpf Bass	6.68	Portasquare
6.3	Filter Bass	6.36	Bpf Disco Bass	6.69	Crazy Chicken
6.4	Fm Square	6.37	Fx Tri Low Byte	6.70	Slow Fm
6.5	Fm Square Reso	6.38	Attack Jazz	6.71	Hard Sync Lead
6.6	Sub Osc	6.39	Sticky	6.72	Stiff Wah
6.7	Straight Sub Wheel	6.40	Rev Freak	6.73	Pick Lead
6.8	Fretless	6.41	Reso Buzz	6.74	Rev Weed
6.9	Unison Click	6.42	Classic Sawbass	6.75	Claro
6.10	Knorr Lfo	6.43	Gritty Baryton	6.76	Mellow Legato
6.11	Wah Mix	6.44	Snapwah	6.77	Thin Wah Legato
6.12	Bpf	6.45	Bow Bass	6.78	Thin Legato
6.13	Vibrator	6.46	Timp Bass	6.79	Gargle
6.14	Straight Knorr	6.47	Maine Theme	6.80	Fat Velo
6.15	Eg Knorr	6.48	Velofifth	6.81	Lyricon
6.16	Reso Square	6.49	Velodecay	6.82	Square Legato
6.17	Oddysey Tuba	6.50	Wirebass	6.83	Desert
6.18	Shortmuffled	6.51	Scream Reed	6.84	Flute
6.19	Hard Velo Wah	6.52	Strung Lead	6.85	Calliope
6.20	Rubber Bass	6.53	Ethnoreed	6.86	Wah Lead
6.21	Clic Bass	6.54	Flury	6.87	Classic Saw
6.22	Fusion Bass	6.55	Raunch Fm	6.88	Classic Pulse
6.23	Raw Bass	6.56	Solo Lylac	6.89	Classic Square
6.24	Fm Attack Bass	6.57	Chiba Flute	6.90	Humming Bird
6.25	Scratch Bass	6.58	Sync Trumpet	6.91	Attack Sync
6.26	Harmonix Bass	6.59	Trombone	6.92	Girls & Boys
6.27	Tine Bass	6.60	Whooley Wah	6.93	Manual Sync
6.28	Chirpy Bass	6.61	Spit Sync	6.94	Slomo Legato
6.29	Ultrafat	6.62	Steth Triangle	6.95	Blues Harp
6.30	Round Bottom	6.63	Velo Winner	6.96	Cool Square
6.31	Ob Bass	6.64	Fifth	6.97	Cyberfiddle
6.32	Reso Bass	6.65	Oriental	6.98	Soft Cream
6.33	Triangle Bass	6.66	Hpf Square	6.99	Syncvoice

BANK 7 (ROM)

Prg	Name	Prg	Name	Prg	Name
7.1	Velo Autobend	7.34	Sync Ep2	7.67	Xylo
7.2	Fat Wah	7.35	Hollow Ep	7.68	Combo Organ -64
7.3	Velo Bppf Sq	7.36	Triangle Ep	7.69	Combo Organ -65
7.4	Growl Wah	7.37	Tri Click Organ	7.70	Zythar
7.5	Poly Sync	7.38	Dance Organ	7.71	Saxy Basson
7.6	Fm Wah	7.39	Omnipulse	7.72	Analog Brass
7.7	Ny	7.40	Spit Bass	7.73	Echo
7.8	Hollow Hack	7.41	Fm Attack Brass	7.74	Distlead
7.9	Bpf Arco	7.42	Det.attack Brass	7.75	Wah Funk
7.10	Bpf Slapper	7.43	Bpf Brass	7.76	Analog Grand 6?
7.11	Filter Funk	7.44	Jump Brass	7.77	Bars
7.12	Wobbler	7.45	Slap Brass	7.78	Sax
7.13	Fm Wah Slap	7.46	Round Fm Horns	7.79	Tremelo 1
7.14	Juicy Organ	7.47	Warm Fm Brass	7.80	Tremelo 2
7.15	Click Organ	7.48	Octave Brass	7.81	Ethno Perc
7.16	Perc	7.49	Gritty Sync	7.82	Thunder Machine
7.17	Italian Organ	7.50	5th Square	7.83	Freak Jingle
7.18	Fm Organ	7.51	Harpeggio	7.84	Noisy Snare
7.19	Fm Jazz Organ	7.52	Horror Industry	7.85	Syntom
7.20	Wah Organ	7.53	Code Burst	7.86	Bubbledrum
7.21	Hard Release	7.54	Random	7.87	Noise Tom
7.22	Metal Kalimba	7.55	Not Fm	7.88	Repet
7.23	Fm Harpo	7.56	Giant Step	7.89	Mockingbird
7.24	Velo Triangle	7.57	Wah Arpeg	7.90	Smelly
7.25	Flute Harp	7.58	Fm Rise Wave	7.91	Small Animals
7.26	Spacebell	7.59	Weird Triad	7.92	Small Ghosts
7.27	Fade Harp	7.60	Ductosnore	7.93	Bubbles
7.28	Swell Pan	7.61	Vibes	7.94	Aiyaa!
7.29	Clicky Bell	7.62	Tremelo Bell	7.95	Glassharmonium
7.30	Warm Plunk	7.63	Swell Bell	7.96	Sunrise
7.31	Sustained Ep	7.64	Steelpan	7.97	Fmbell
7.32	Octave Ep	7.65	Long Bell	7.98	Slow/fast Wah
7.33	Sync Ep1	7.66	Ringer	7.99	Whellmorpher

PROGRAM BANKS 8-9

BANK 8 (ROM)

Prg	Name	Prg	Name	Prg	Name
8.1	Prowler Bass	8.34	Knocky Electric Piano	8.67	Cricketer Pad
8.2	Aurora Borealis	8.35	Stereo Synth String Pad	8.68	Meep meep
8.3	Crisp-n-Snappy Bass	8.36	Delicate Bell	8.69	Delay Techno Res
8.4	Crisp-n-Dark Bass	8.37	Noisy Bell	8.70	Delay Synth Bass
8.5	Snappy Attack Bass	8.38	Alubasium	8.71	Delay Techno Squares
8.6	Dark-n-Funky Bass	8.39	Mr.Killer Synth Lead/Bass	8.72	Delay Future Square
8.7	RUDE Bass	8.40	Super Secret(!) Filter Pad	8.73	Delay Notch Sawtooth
8.8	Euro/Disco Bass	8.41	Tea five	8.74	Delay NIGHTMARE
8.9	Velo-Edge Bass	8.42	PWM Repeat Pad	8.75	Delay Noises 1
8.10	Skip's Dark Bass	8.43	SAW Rap Lead	8.76	Delay Noises 2
8.11	Secret Mission Bass	8.44	TRI Rap Lead	8.77	Delay Noises 3
8.12	ResoRave Bass	8.45	Attackforce	8.78	Delay Res Sawtooth
8.13	Solid Snap Bass	8.46	Scritty Nitry	8.79	Tuned Resonance Pad 2
8.14	Fun with Wheel Bass	8.47	Happy Res Popper	8.80	Monster Lead Saw
8.15	Solid Cracker Bass	8.48	BPFilter Funky Velo Claw	8.81	Monster Lead Square
8.16	Mild Buzz Bass	8.49	Obi 1 kenobi	8.82	Pheabee
8.17	Wonder Bass	8.50	Idaho Snow Pad	8.83	Alien Wind
8.18	Stereo Square Bass	8.51	Slow Soft String Pad	8.84	Velocity Res Synth
8.19	Phunky Chunky Bass	8.52	Purple Pad	8.85	Arpeggiated Reso
8.20	Happy Clavi Bass	8.53	Pointed Triangles	8.86	Arpeggiated Square
8.21	Hybrid Piano Pad	8.54	Jazz Guitar	8.87	Arpeggiated Velo Bass
8.22	Notchy Psycho	8.55	Slowly in Sync Pad	8.88	Aggrevated S&H
8.23	Soft Square Pad	8.56	***Only for Techno***	8.89	Strike&Wait
8.24	Bowed String Ensemble	8.57	Harmonis Pad	8.90	Velocity HiHat 1
8.25	Solo Violin	8.58	Funky Piano	8.91	Velocity HiHat 2
8.26	Solo Cello	8.59	Ocean Sunrise (5th. Pad)	8.92	Velocity HiHat 3
8.27	Phunky Street Reso-Lead	8.60	Sci-Fi Notch Pad	8.93	Velocity HiHat 4
8.28	Sustain Pluck	8.61	Mono Clav with Sustain	8.94	Velocity HiHat 5
8.29	Dirty Sine Pad	8.62	Chubby Pad	8.95	Snappy Tuned Res
8.30	Slave Pad	8.63	Soft Pluck Bell	8.96	Noize Snare
8.31	Snappy Mello Synth	8.64	Old Organ w/ Rotary Sp	8.97	909 Kick 1 (C3)
8.32	Super Stereo Synth Brass	8.65	Older Organ w/ Rotary Sp	8.98	909 Kick 2
8.33	Stab Synth	8.66	Slow Growing Pad	8.99	909 Kick 3

BANK 9 (ROM)

Prg	Name	Prg	Name	Prg	Name
9.1	FlangeBass	9.34	Pupi	9.67	Nervouzz
9.2	Razorblade	9.35	JuiciPulse	9.68	Harpoon
9.3	Flageocello	9.36	BantuNoizz	9.69	Delayla
9.4	Syncopathy	9.37	Teabea	9.70	Conventor
9.5	Morphyne	9.38	RoadReed	9.71	Schumi
9.6	Bruss	9.39	RoadTone	9.72	Ravor
9.7	Puncher	9.40	BumbleBees	9.73	Pulsebee
9.8	Leader	9.41	TynDrum	9.74	U97
9.9	Kraftwerk	9.42	Moogger	9.75	Cavechant
9.10	Monsta	9.43	NerveBazz	9.76	Big hand
9.11	Yupita	9.44	NotNice	9.77	Alllaaaarrrm
9.12	Zzzing	9.45	BigBoy	9.78	Propella
9.13	Cellizim	9.46	Hardwurz	9.79	Atmosfear
9.14	Morphorgan	9.47	MMEB	9.80	Vibeggator
9.15	Divva	9.48	Brednbutta	9.81	Vintager
9.16	Scritty Gritty	9.49	Syncalong	9.82	Wheelraiz
9.17	Velocello	9.50	Zumpal	9.83	Yazza
9.18	Himalaya	9.51	SubWheel	9.84	Strumma
9.19	Speakalead	9.52	Idontlike	9.85	ClaviGum
9.20	Delayline	9.53	Impressor	9.86	ClaviBass
9.21	Simplebars	9.54	Morphium	9.87	VanOrgan
9.22	Motor	9.55	Discofat	9.88	Squonk
9.23	TB-Morph	9.56	Disturbor	9.89	Cymbell
9.24	Subtone	9.57	Frogdelay	9.90	Vinylation
9.25	Nohat	9.58	Padigree	9.91	SciFifi
9.26	Footclap	9.59	Show-off	9.92	Ueeceel
9.27	Pulsyboy	9.60	Popular	9.93	CompuBird
9.28	TimeSquare	9.61	Bladerunner	9.94	Nicebeach
9.29	Resomorph	9.62	Ham and X	9.95	ReeVerb
9.30	PitchaPad	9.63	Rockamoog	9.96	Blondes
9.31	Multimoog	9.64	WorldWar	9.97	Extream
9.32	DefinerBass	9.65	Simpleseq	9.98	Take Care
9.33	NastySeq	9.66	NoizzBecker	9.99	Softie

PERCUSSION KITS

BANK 0 (RAM)

Kit	Name	Kit	Name
P0	Synth Kit 0	P5	Synth Kit 5
P1	Synth Kit 1	P6	Synth Kit 6
P2	Synth Kit 2	P7	Synth Kit 7
P3	Synth Kit 3	P8	Synth Kit 8
P4	Synth Kit 4	P9	Synth Kit 9

BANK 1 (RAM)

Kit	Name	Kit	Name
1.P0	Synth Kit 10	1.P5	Synth Kit 15
1.P1	Synth Kit 11	1.P6	Synth Kit 16
1.P2	Synth Kit 12	1.P7	Synth Kit 17
1.P3	Synth Kit 13	1.P8	Synth Kit 18
1.P4	Synth Kit 14	1.P9	Synth Kit 19

BANK 2 (RAM)

Kit	Name	Kit	Name
2.P0	Synth Kit 20	2.P5	Synth Kit 25
2.P1	Synth Kit 21	2.P6	Synth Kit 26
2.P2	Synth Kit 22	2.P7	Synth Kit 27
2.P3	Synth Kit 23	2.P8	Synth Kit 28
2.P4	Synth Kit 24	2.P9	Synth Kit 29

BANK 3 (RAM)

Kit	Name	Kit	Name
3.P0	Synth Kit 30	3.P5	Synth Kit 35
3.P1	Synth Kit 31	3.P6	Synth Kit 36
3.P2	Synth Kit 32	3.P7	Synth Kit 37
3.P3	Synth Kit 33	3.P8	Synth Kit 38
3.P4	Synth Kit 34	3.P9	Synth Kit 39

PERFORMANCE BANKS 0-1

BANK 0 (RAM)

Perf	Name	Perf	Name
A0	Arpaddio	F0	Percussive COMP 1
A1	Slow Huge Mono Lead	F1	Sly Stone Bass
A2	Tri Bounce Pad	F2	Percussive COMP 2
A3	Round Techno Bass	F3	Monster Lead
A4	Terminated - MIX 3	F4	Moog Bass 1
A5	Alien Walking-MIX 1	F5	Moog Bass 2
A6	FutureSYNC - MIX 1	F6	Mini Lead 3
A7	Synth Grand Pad	F7	Fun with the Sync!
A8	Synth Bass in your Face 1	F8	Percussive COMP 3
A9	Stereo Synth Bass 4	F9	Shadow of a Cello
B0	Plucked Pad	G0	Enlightening Pad
B1	Phatt Bass	G1	Dramatic Pad
B2	OB Talk	G2	ARP w/ Swept Pad
B3	Moog Lead	G3	Introspective Pad
B4	FM Metalimba	G4	ARP Erasure
B5	Delicate Drama	G5	VEL TRI Synth
B6	Alternate Xylo	G6	Cybernetic Clav
B7	ARP Sequence	G7	Synth Brass Section
B8	Delerium Pad	G8	Big Chime Pad
B9	Synth Brass Attack	G9	Hi-Pass VEL Funky Clav
C0	Totally Rude Synth Lead 2	H0	LFO Electronica
C1	Cyber Suite 1d	H1	2 Step Bass
C2	Synth Bass in your Face 10	H2	Delicate Roads :-)
C3	Stereo Synth Bass 5	H3	Pick Bass
C4	Small Church Organ	H4	Delicate Roads 2 :-)
C5	Funky Clav	H5	Wurl!
C6	Alien Walking-MIX 4	H6	Hybrid WurlRhodes
C7	Hi Res Pad	H7	Resonant SAWS 1
C8	Goodbye Pad 3	H8	Delicate Pick
C9	Clavi Piano	H9	Resonant SAWS 2
D0	Cave Pad	J0	Hi-Pass Clav
D1	Percussiveness	J1	Wide Talker
D2	Notch Bass	J2	Smooth Bass
D3	Repeater	J3	Rising Pad
D4	Seq's Appeal	J4	SYNC Clav
D5	Wavepad	J5	Thick Bass
D6	Space Station	J6	RAVE Synth
D7	3 Layer Lead	J7	Paisley Park Synth
D8	Church Organ	J8	Organesque
D9	Koto	J9	Grunge Bass
E0	Harp With Strings	L0	FM Bass
E1	Babar	L1	Alternating COMP
E2	Industri	L2	Plastic Bass
E3	Nice Arpeggi	L3	Super REZ
E4	Grand Canyon	L4	REZonant Trails
E5	Overblow	L5	REZ Mini Lead
E6	Poww5	L6	Funk Clav
E7	Synthfactory 1	L7	Chilled REZ
E8	Resonantsweep 2	L8	D&B Bass
E9	Talking Clav	L9	Alternating Techno 2

BANK 1 (ROM)

Perf	Name	Perf	Name
1.A0	Bellbrass pad	1.F0	Jungle
1.A1	Heavy sync sweep	1.F1	Acid song
1.A2	Big lead	1.F2	Bottle
1.A3	Orchestra bell	1.F3	ET go home
1.A4	Pulse sweep with a twist	1.F4	Acc gitar
1.A5	Reverb choir	1.F5	Power bells
1.A6	Majestix	1.F6	Voices
1.A7	Arpeggiator string pad	1.F7	Bells
1.A8	Plucking pad	1.F8	The wheel morph
1.A9	Arpeggiator heaven	1.F9	Attack
1.B0	Sixtiffive organ	1.G0	Piano pad
1.B1	Wow pad	1.G1	Harp
1.B2	Windy	1.G2	Echo from africa
1.B3	Water organ	1.G3	Sweep pad
1.B4	Big Morph	1.G4	Magic night
1.B5	Heavy pulse lead	1.G5- 1.H7	Drawbar Organs (see below)
1.B6	Westminister	1.H8- 1.J9	Prophet 5 Factory Patch Recreations (see page 101)
1.B7	Strings and bells	1.L0- 1.L9	Nord Lead 2 RAM Programs 1-40 (see page 102)
1.B8	The Jazz duo		
1.B9	Ambient bell		
1.C0	Big pulse		
1.C1	Unison FM lead		
1.C2	Rise and fall		
1.C3	Greek stuff		
1.C4	Octave sweep		
1.C5	Cyber piano		
1.C6	Pan flute		
1.C7	Metal sweep		
1.C8	Sax-o-phone		
1.C9	Mouth flute		
1.D0	Acid clock		
1.D1	Future pipe		
1.D2	Stereo Pad		
1.D3	Wheel lead		
1.D4	Expressive Lead		
1.D5	Techno song		
1.D6	Brass pad		
1.D7	Saw Sweep		
1.D8	Brite string pad		
1.D9	Space engine		
1.E0	Square organ		
1.E1	Saw pulse pad		
1.E2	Analog grand bass		
1.E3	Raga on white keys		
1.E4	Soft string pad		
1.E5	Voice 1		
1.E6	Voice 2		
1.E7	Voice 3		
1.E8	Dist lead		
1.E9	Big bell		

PERFORMANCE BANKS 2-3

BANK 2 (ROM)

Perf	Name	Perf	Name
2.A0	Breath Pad	2.F0	Aggressive SAW 1
2.A1	FutureSYNC - MIX 2	2.F1	Alien Walking-MIX 2
2.A2	FutureSYNC - MIX 3	2.F2	Alien Walking-MIX 3
2.A3	Big Bold Movie Pad	2.F3	VEL Reso Lead
2.A4	Hybrid Chorused Piano	2.F4	DARK Pad
2.A5	Terminated - MIX 1	2.F5	Westside Bass
2.A6	Terminated - MIX 2	2.F6	Stereo Rap Lead
2.A7	Punchy Polysynth	2.F7	Rushing ARP Pad
2.A8	Terminated - MIX 4 (Breakdwn)	2.F8	Res Sweep in Fifths
2.A9	Terminated - MIX 5	2.F9	Stereo Solo String
2.B0	Disco Toy Shop - Mix 1	2.G0	Mono String Pad
2.B1	Disco Toy Shop - Mix 2	2.G1	Goodbye Pad 1
2.B2	Totally Rude Synth Lead 1	2.G2	Goodbye Pad 2
2.B3	ARPeGIator	2.G3	Alternating Pluck
2.B4	Stereo Pluck Pad	2.G4	Cyber Man
2.B5	Cyber Split	2.G5	Impact Synth Pad
2.B6	Cyber Suite 1a	2.G6	Nasty Sync Bass
2.B7	Cyber Suite 1b	2.G7	Stereo Synth Brass
2.B8	Cyber Suite 1c	2.G8	Digi Bell Pad
2.B9	Funk TALK Bass	2.G9	Teddy's Talkbox
2.C0	S&H Pad	2.H0	DARK SQUARE Pad
2.C1	Synth Bass in your Face 2	2.H1	Snappy Square Pad
2.C2	Synth Bass in your Face 3	2.H2	Stereo Electric Piano
2.C3	Synth Bass in your Face 4	2.H3	Knocky F.M. Electric Piano
2.C4	Synth Bass in your Face 5	2.H4	Soft Tyne Electric Piano
2.C5	Synth Bass in your Face 6	2.H5	Ballad Electric Piano
2.C6	Synth Bass in your Face 7	2.H6	Electric Pianette
2.C7	Synth Bass in your Face 8	2.H7	Simple Electric Piano
2.C8	Synth Bass in your Face 9	2.H8	Synth Harp
2.C9	Techno Echo	2.H9	Funk Claw
2.D0	Stereo Synth Bass 1	2.J0	Acoustic Guitar
2.D1	Stereo Synth Bass 2	2.J1	Crazy SAW
2.D2	Stereo Synth Bass 3	2.J2	Old School Funk
2.D3	Atmospheric Pad	2.J3	Wurlitzer
2.D4	Pluck Synth Bass 1	2.J4	Mystery Pad
2.D5	Pluck Synth Bass 2	2.J5	Aggressive SAW 2
2.D6	Alternating Techno 1	2.J6	SAW/SQU Mix
2.D7	Oblong Synth Bass	2.J7	Increased Velocity FX
2.D8	Face Bass	2.J8	Dramatic Sweep
2.D9	VEL Reso Bass	2.J9	SAW/TRI Mix
2.E0	Sustained Guitar Pad	2.L0	Cheesy Farfisa
2.E1	Talking REZ Triangles	2.L1	Short Wave Opera
2.E2	Sick, Cheesy Organ	2.L2	FM Xylo
2.E3	Healthy, Cheesy Organ	2.L3	Band Pass Funk
2.E4	Stereo Pluck Pad	2.L4	Band Pass Pad
2.E5	SweePed Pad	2.L5	Sustained REZ
2.E6	Age of Techno	2.L6	Delicate Triangle
2.E7	Slow Huge Mono Lead	2.L7	Filter Bass
2.E8	Crystal Melody Bell	2.L8	Attack Fifth
2.E9	Whirly and Pad	2.L9	Jazz Organ

BANK 3 (ROM)

Perf	Name	Perf	Name
3.A0	Bass 1	3.F0	Backwardchords
3.A1	Bass 2	3.F1	Metalfedback
3.A2	Bass 3	3.F2	Pagan
3.A3	Fifth Drawbar	3.F3	Ghost
3.A4	Autowah Bass	3.F4	Friday13th
3.A5	Mouth Bass	3.F5	Ep W Room
3.A6	Snapsync	3.F6	Magic Room
3.A7	Deep Kalimba	3.F7	Low Organ W Click
3.A8	Attackbass	3.F8	Elpiano
3.A9	Horrorwave	3.F9	Fat Percbass
3.B0	Good Morning	3.G0	Resonantsweep 1
3.B1	Polyrhythm Hat	3.G1	Bass 12
3.B2	Jazzy Scat	3.G2	Portamentolead
3.B3	Woodbass	3.G3	Funky Steel
3.B4	Fusionbasic	3.G4	Birds & Bells
3.B5	Pulse	3.G5	Soft Glass
3.B6	Square Slapbass	3.G6	Mikes Favorite
3.B7	Nasty Organ	3.G7	Seq 1
3.B8	Wah Koto Lead	3.G8	Seq 2
3.B9	Polyfilter	3.G9	Seq 3
3.C0	Wah Brass	3.H0	Timpany
3.C1	Thin Brass	3.H1	Reso
3.C2	Tines	3.H2	Bas Arp
3.C3	Ballad Ep	3.H3	Pleasure To Be Sad
3.C4	Wheel Dist	3.H4	Devil
3.C5	Unison Horns	3.H5	Arp 1
3.C6	Fat Guitar	3.H6	Arp 2
3.C7	Zynthar 2	3.H7	Soft
3.C8	Gods Harmonium	3.H8	Harmony
3.C9	Soft Sermon	3.H9	Voice
3.D0	Bass 6	3.J0	Why?
3.D1	Velo Cello	3.J1	Delay
3.D2	Multi Arco	3.J2	Arp 3
3.D3	Triple Bass	3.J3	Super Synt 1
3.D4	Softintervall	3.J4	Super Synt 2
3.D5	Rob's Arpeggio	3.J5	Arp 4
3.D6	Rob's Arpeggio 2	3.J6	Wheel Morph 1
3.D7	Pentatonic	3.J7	Wheel Morph 2
3.D8	Dewe8000	3.J8	Crazy
3.D9	Bass/hihat Rythm	3.J9	Deepsnare/roll On Velocity
3.E0	Bass/hihat Rythm 2	3.L0	Horror String 1
3.E1	Calling Erth	3.L1	Horror String 2
3.E2	Bass 9	3.L2	Horror String 3
3.E3	Winter Storm	3.L3	Horror String 4
3.E4	Church Organ 1	3.L4	Wetlayer
3.E5	Reverbsynth	3.L5	Challenger
3.E6	Lasresynth	3.L6	Lfo
3.E7	Bass 10	3.L7	Softmetal
3.E8	Padlayer	3.L8	Attackpad
3.E9	Acc.bass	3.L9	Synthfactory 2

Please note that many of the Performances consist of two-, three- or four-Slot layers, which will lead to reduced polyphony.

ABOUT THE ORGAN SOUNDS

Factory Performances 1.G5-1.H7, holds reproductions of 13 classic organ sounds. By using layers of several Slots, combined with a special “pseudo-additive” synthesis, Clavia have filtered out a minor number of “partials” from each Oscillator and combined them into different drawbar configurations, successfully emulating the sound of drawbar organs such as the classic B-3.

DRAWBAR ORGAN ESSENTIALS

To make best use of the organ emulations and their special features, some knowledge about the original instruments might be of use. Briefly, the following building blocks were combined to create the drawbar organ sounds:

TONEWHEELS

These are the basic sound-generating devices. In the Nord Lead 2X, they are of course replaced by the Oscillator section.

DRAWBARS

These are click-stopped “sliders”, usually nine, each one controlling the volume of a certain partial in the organ tone. The partials are indicated in the classic pipe organ way, referring to the length of the organ pipes. Thus, the standard drawbar configuration is (from the bottom up):

16'	5 1/3'	8'	4'	2 2/3'	2'	1 3/5'	1 1/3'	1'
-----	--------	----	----	--------	----	--------	--------	----

By using the drawbars to change the balance between the partials, the harmonic content of the organ tone can be changed.

In the Nord Lead 2X organ sounds, the oscillators are used to generate the partials. In some cases, there is a direct “one oscillator - one drawbar” relation; other sounds use more complex waveforms to simulate up to three combined partials with one oscillator. Usually, the oscillators in each slot are paired, so that Oscillator 1 generates the lower partial(s) and Oscillator 2 the higher. Therefore, you can give the sound more bottom or edge, by changing the Oscillator balance with the Mix knob for each Slot.

PERCUSSION

To add some attack to the sound, most classic organs feature Percussion - an accent-like tone with fast attack, short decay and no sustain. Usually the pitch of the Percussion tones are 4' or 2 2/3' (or both mixed), in effect replacing the corresponding drawbar partials. Some of the Nord Lead 2X organ sounds make use of Percussion in Slot B. You can vary the balance between the two Percussion pitches with the Mix knob, and also change the Decay time of the Percussion tone to make it fit your playing style.

CLICK

Though not an intended feature on the classic organs, the short, non-pitched click noise when keys are pressed has become a popular characteristic. In the organs, the sound came from oxidation on the key switches; in the Nord Lead 2X you can add or remove the click as desired. All of the Nord Lead 2X organ Performances has the click sound on Slot D, although it is by default turned off for some of the sounds.

HUM

This inharmonic, thin sound is also an unintended artifact, generated by leakage between the tonewheels in the organs. It is included in some of the Nord Lead 2X organ sounds, adding even further realism.

ROTARY SPEAKER

A large part of the characteristic organ sound is due to the rotary speaker cabinet. Such a cabinet “moves the sound” around, either by rotating the actual speakers, or by directing the sounds with rotating baffles or horns. Usually, the rotation speed can be changed from slow (producing a full chorus-like effect) to fast (producing a very special doppler-shifted tremolo sound). Several of the organ sounds in the Nord Lead 2X include a Rotary Speaker effect, emulated by the LFO:s and the Morph function. Change the rotor speed from slow to fast by raising the Modulation wheel.

This table shows the drawbar configurations simulated by each organ Performance. The configuration is indicated by 9 numbers, volume settings (0 - 8) for each drawbar in the simulated sound.

For all Performances, you can activate Slot D to add Click to the sound.

Performance	Name	Drawbar configuration	Extras	Rotary Spkr.
1.G5	Perc 3rd w click	880 000 000	Slot B: Perc. Slot C: Hum	No
1.G6	NHL	808 000 022		No
1.G7	W. Shade of Pale	888 600 000		Yes
1.G8	Straight Jazz Perc	888 000 000	Slot B: Perc. Slot C: Hum	No
1.G9	Soul Rotor	888 222 222		Yes
1.H0	One high	888 000 008		Yes
1.H1	All Even Harmonics	808 808 008		Yes
1.H2	Odd Upper Harmonics	888 040 440		Yes
1.H3	All Out	888 888 888		Yes
1.H4	Cathedral Organ	864 212 468		Yes
1.H5	Low	876 543 211		Yes
1.H6	Mid	124 686 421		Yes
1.H7	Super Brite	112 345 678		Yes

ABOUT THE PROPHET-5 SOUND RECREATIONS

Over 40 of the 120 original factory sounds from the classic vintage “Prophet 5” synthesizer have been faithfully recreated and stored in the Factory Performances of the Nord Lead 2X. You find the Prophet sounds in Performance memory locations 1.H8 to 1.J9.

Since each of these sounds uses one Slot only, four different Prophet sounds have been stored in each Performance. To try out the different Patches in one Performance, select slot A, B, C or D, by pressing the respective SLOT button. The names of the recreated Prophet 5 patches refer to their original location in the Prophet 5 program banks.

Performance	Slot A	Slot B	Slot C	Slot D
1.H8	Bank 1-11	Bank 1-12	Bank 1-13	Bank 1-14
1.H9	Bank 1-15	Bank 1-16	Bank 1-17	Bank 1-18
1.J0	Bank 1-21	Bank 1-22	Bank 1-23	Bank 1-24
1.J1	Bank 1-25	Bank 1-26	Bank 1-27	Bank 1-28
1.J2	Bank 1-31	Bank 1-32	Bank 1-33	Bank 1-34
1.J3	Bank 1-35	Bank 1-36	Bank 1-37	Bank 1-38
1.J4	Bank 1-41	Bank 1-42	Bank 1-43	Bank 1-44
1.J5	Bank 1-45	Bank 1-46	Bank 1-47	Bank 1-48
1.J6	Bank 2-41	Bank 1-52	Bank 1-53	Bank 1-54
1.J7	Bank 1-55	Bank 1-56	Bank 1-57	Bank 1-58
1.J8	Bank 3-12	Bank 2-36	Bank 2-37	Bank 2-52
1.J9	Bank 2-54			

NORD LEAD 2 RAM FACTORY PROGRAMS

The 40 original RAM Factory Programs of the Nord Lead 2 are featured in ROM Performances 1.L0 to 1.L9, as listed below. To extract one of these sounds from its Performance, and store it as a regular Program, follow the instructions on [page 35](#).

Performance	Slot A	Slot B	Slot C	Slot D
1.L0	Program 01	Program 02	Program 03	Program 04
1.L1	Program 05	Program 06	Program 07	Program 08
1.L2	Program 09	Program 10	Program 11	Program 12
1.L3	Program 13	Program 14	Program 15	Program 16
1.L4	Program 17	Program 18	Program 19	Program 20
1.L5	Program 21	Program 22	Program 23	Program 24
1.L6	Program 25	Program 26	Program 27	Program 28
1.L7	Program 29	Program 30	Program 31	Program 32
1.L8	Program 33	Program 34	Program 35	Program 36
1.L9	Program 37	Program 38	Program 39	Program 40

13. MIDI IMPLEMENTATION

MIDI CONTROLLER LIST

The following is a list of the MIDI Controller numbers used for all knobs and buttons on the front panel. See [page 77](#).

- The reception and transmission of Controllers can be turned on/off. See [page 66](#).
- Buttons that control “on/off” functions have a Controller value of “0” corresponding to the “off” position and a value of “on” corresponding to the “on” position.
- Buttons that step through various possibilities start with a Controller value of “0” for the “lowest” setting and then increment with a value of 1 for each step upwards.

If you want to send Controllers to Percussion Kits, proceed with caution! The Controller message you send will affect the percussion sound that was last selected for editing, by pressing a black key on the keyboard (see [page 29](#)).

Nord Lead 2X Parameter	MIDI Controller #	MIDI Controller Name
Gain	7	Main Volume
Oct Shift	17	General Purpose #2
Mod Wheel Destination	18	General Purpose #3
Unison	16	General Purpose #1
Poly/Legato/Mono	15	Undefined
Portamento Auto	65	Portamento On/Off
Portamento Time	5	Portamento Time
LFO 1 Rate	19	General Purpose #4
LFO 1 Waveform	20	Undefined
LFO 1 Destination	21	Undefined
LFO 1 Amount	22	Undefined
LFO 2/Arpeggio Rate	23	Undefined
LFO 2 Destination/Arpeggio Mode	24	Undefined
LFO 2 Amount/Arpeggio Range	25	Undefined
Modulation Envelope Attack	26	Undefined
Modulation Envelope Decay	27	Undefined
Modulation Envelope Destination	28	Undefined
Modulation Envelope Amount	29	Undefined

Nord Lead 2X Parameter	MIDI Controller #	MIDI Controller Name
Osc 1 Waveform	30	Undefined
Osc 2 Waveform	31	Undefined
Osc 2 Semitones	78	Sound Controller 9
Osc 2 Fine Tune	33	LSB for Controller 1
Oscillator FM Depth	70	Sound Controller 1 (Sound Variation)
Osc 2 Keyboard Tracking	34	LSB for Controller 2
Oscillator Pulse Width	79	Sound Controller 10
Oscillator Sync	35	LSB for Controller 3
Oscillator Mix	8	Balance
Amplifier Envelope Attack	73	Sound Controller 4 (Attack)
Amplifier Envelope Decay	36	LSB for Controller 4
Amplifier Envelope Sustain	37	LSB for Controller 5
Amplifier Envelope Release	72	Sound Controller 3 (Release)
Filter Envelope Attack	38	LSB for Controller 6
Filter Envelope Decay	39	LSB for Controller 7
Filter Envelope Sustain	40	LSB for Controller 8
Filter Envelope Release	41	LSB for Controller 9
Filter Mode	44	LSB for Controller 12
Filter Cutoff	74	Sound Controller 2 (Timbre)
Filter Resonance	42	LSB for Controller 10
Filter Envelope Amount	43	LSB for Controller 11
Filter Velocity	45	LSB for Controller 13
Filter Keyboard Track	46	LSB for Controller 14
Filter Distortion	80	

In addition to the above, following controllers are used:

- The Modulation wheel transmits and receives Controller 1.
- If the Pedal input is used with an expression pedal, this is transmitted and received as Controller 11.
- If the Pedal input is used for sustain, this is transmitted as Controller 64 (Damper Pedal)
- Bank Select messages are transmitted and received as Controller 32.

SYSTEM EXCLUSIVE IMPLEMENTATION

Numbers are in decimal except when preceded by a “\$” character, in which case they are in hexadecimal format.

GENERAL MESSAGE FORMAT

Byte	Description
\$F0	System Exclusive
\$33	Manufacturer ID (clavia)
<Device ID>	= Global MIDI Channel, 0-15
\$04	Model ID for Nord Lead 2X
<Message Type>	See each type of message, below.
<Message Specification>	See each type of message, below.
<Data 1>	This and following bytes depend on the Message Type and Message Specification. Some messages have no data bytes at all.
<Data 2>	
<Data 3>	
<etc.>	
\$F7	End Of Exclusive

PATCH DUMPS

This message contains the actual Patch Dump. One complete message contains the data for one Patch. It is transmitted *from* the Nord Lead 2X in one of two cases:

- When a Patch Dump is initiated from the front panel.
- When a valid Patch Dump Request message has been received.

This message should be sent *to* the Nord Lead 2X when you want to replace a Patch currently in the instrument, with a new one.

The Message Type and Message Specification bytes in the Sys Ex message contains information about from which location the Patch Dump was sent. When a Patch is sent to the Nord Lead 2X, it will end up in this location.

- If the Sys Ex data *for a complete Bank* is sent (using the “Dump All” command), the Program location within the Bank is stored for each Patch. When any or all of these Patches are sent back to a Nord Lead 2X, they will be stored at their original Program Location, but in the Bank that is currently selected on the Nord Lead 2X.
- If the Sys Ex data for a single Patch is sent *using the “Dump One” command*, it is considered being sent from the *Edit Buffer of the selected Slot*. This means, that when the Patch is sent back to a Nord Lead 2X, it will not actually be stored, but temporarily placed in the Edit Buffer of its original Slot.

- If the Sys Ex data for a single Patch is sent *upon receiving a Patch Dump Request message*, either the Program Location or the Edit Buffer will be stored, depending on the Message Type byte in the Request message. This will also determine where the Patch will be placed when it is sent back to a Nord Lead 2X.

Byte (Hex)	Byte (Decimal)	Description
\$F0	240	System Exclusive
\$33	51	Manufacturer ID (clavia)
<Device ID>		= Global MIDI Channel. 0 to 15 (\$0-\$F).
\$04	4	Model ID for Nord Lead 2X
\$00 to \$0A	0 to 10	Message Type specifies the Bank. 0=Edit Buffer, 1 to 10 =Bank 1 to 10
\$00 to \$03 or \$00-\$62	0 to 3 or 0 to 98	Message Specification specifies the exact memory location, see below.
<Patch Data 1>		See page 111 .
<Patch Data 2>		
<Patch Data 3>		
:		
<Patch Data 132>		
\$F7	247	End Of Exclusive

- If Message Type = 0 (Edit Buffer), the Message Specification can be 0 to 3, corresponding to Patch Slot buttons A to D.
- If Message Type = 1 to 10, then the Message Specification (00 to 98) corresponds to the Program Number within the Bank (01 to 99).

PERCUSSION KIT PATCH DUMP

This message contains all settings in a Percussion Kit. It is transmitted *from* the Nord Lead 2X in one of two cases:

- When a Patch Dump is initiated from the front panel and a Percussion Kit is selected.
- When a valid Patch Dump Request message has been received, specifying a Percussion Kit location or an Edit Buffer containing a Percussion Kit.

Percussion Kit Patch Dump messages will also be sent if the “Dump All” command is used.

This message should be sent *to* the Nord Lead 2X when you want to replace a Percussion Kit currently in the instrument, with a new one. When it comes to the location of the received Percussion Kit Dumps, the same rules apply as when receiving regular Program Dumps.

Byte (Hex)	Byte (Decimal)	Description
\$F0	240	System Exclusive
\$33	51	Manufacturer ID (clavia)
<Device ID>		= Global MIDI Channel. 0 to 15 (\$0-\$F).
\$04	4	Model ID for Nord Lead 2X
\$00 to \$04	0 to 4	Message Type specifies the Bank. 0=Edit Buffer, 1 to 4=Bank 1 to 4
\$10 to \$13 or \$63-\$6C	16 to 19 or 99 to 108	Message Specification specifies the exact memory location, see below.
<Patch Data 1>		Patch data for eight percussion sounds. See page 111 .
<Patch Data 2>		
<Patch Data 3>		
:		
<Patch Data 1056>		
\$F7	247	End Of Exclusive

- If Message Type = 0 (Edit Buffer), the Message Specification can be 16 to 19, corresponding to Patch Slot buttons A to D.
- If Message Type = 1 to 4, then the Message Specification (99 to 108) corresponds to the Percussion Kit locations (P0 to P9) of the selected Bank.

PATCH DUMP REQUEST

This message is used for requesting the Nord Lead 2X to transmit one Patch or Percussion Kit Dump Message. The Message Type and Message Specification are used to specify which Patch should be transmitted.

This message is never transmitted *from* the Nord Lead 2X.

Byte (Hex)	Byte (Decimal)	Description
\$F0	240	System Exclusive
\$33	51	Manufacturer ID (clavia)
<Device ID>		= Global MIDI Channel. 0 to 15 (\$0-\$F).
\$04	4	Model ID for Nord Lead 2X
\$A to \$E	10 to 14	Message Type specifies the Bank. \$A=Edit Buffer, \$B to \$E=Bank 1 to 4

Byte (Hex)	Byte (Decimal)	Description
\$00 to \$03 or \$00-\$6C	0 to 3 or 0 to 108	Message Specification specifies the exact memory location, see below.
\$F7	247	End Of Exclusive

- If Message Type = 10 (Edit Buffer), the Message Specification can be \$00 to \$03, corresponding to Patch Slot buttons A to D.
- If Message Type = 11 to 14, then the Message Specification (00 to 98) corresponds to the Program Number within the Bank (01 to 99).

PERFORMANCE DUMP

This message contains the actual Performance. One complete message contains the data for one Performance.

This message is transmitted *from* the Nord Lead 2X in one of two cases:

- When a Performance Dump is initiated from the front panel.
- When a valid Performance Request message has been received.

This message should be sent *to* the Nord Lead 2X when you want to replace a Performance currently in the instrument, with a new one. The Message Type and Message Specification then specify in which memory location the Performance should be stored.

Byte (Hex)	Byte (Decimal)	Description
\$F0	240	System Exclusive
\$33	51	Manufacturer ID (clavia)
<Device ID>		= Global MIDI Channel. 0 to 15 (\$0-\$F).
\$04	4	Model ID for Nord Lead 2X
\$1E or \$1F-\$22	30 or 31-34	Message Type specifies Performance Edit Buffer (30) or Performance Bank 1-4 (31-34)
\$00 or \$00-\$63	0 or 0 to 99	Message Specification specifies the Performance number, see below.
<Perf. Data 1>		See page 112 .
<Perf. Data 2>		
<Perf. Data 3>		
:		
<Perf. Data 708>		
\$F7	247	End Of Exclusive

- If Message Type = 30 (Edit Buffer), the Message Specification should always 0.
- If Message Type = 31-34, the Message Specification corresponds to the Performance Number (00 to 99) within the selected Bank.

PERFORMANCE DUMP REQUEST

This message is used for requesting the Nord Lead 2X to transmit one Performance Dump Message. The Message Type and Message Specification are used to specify which Performance should be transmitted.

This message is never transmitted *from* the Nord Lead 2X.

Byte (Hex)	Byte (Decimal)	Description
\$F0	240	System Exclusive
\$33	51	Manufacturer ID (clavia)
<Device ID>		= Global MIDI Channel. 0 to 15 (\$0-\$F).
\$04	4	Model ID for Nord Lead 2X
\$28 or \$29-\$2C	40 or 41-44	Message Type specifies Performance Edit Buffer (40) or Performance Banks 1-4. (41-44).
\$00 or \$00-\$63	0 or 0 to 99	Message Specification specifies the Performance number, see below.
\$F7	247	End Of Exclusive

- If Message Type = 40 (Edit Buffer), the Message Specification should always 0.
- If Message Type = 41 or 42, then the Message Specification (00 to 99) corresponds to the Performance Number (A0 to L9).

ALL CONTROLLERS REQUEST

This message instructs the Nord Lead 2X to send all current Controller values for a specified Slot (see [page 78](#)). The message is never transmitted *from* the Nord Lead 2X.

Byte (Hex)	Byte (Decimal)	Description
\$F0	240	System Exclusive
\$33	51	Manufacturer ID (clavia)
<Device ID>		= Global MIDI Channel. 0 to 15 (\$0-\$F).
\$04	4	Model ID for Nord Lead 2X
\$14	20	Message Type specifies All Controllers Request.
\$00-\$03	0 to 3	Message Specification specifies the Slot.
\$F7	247	End Of Exclusive

PATCH AND PERFORMANCE DATA FORMATS

In the Patch and Performance Dump Messages, the Data Bytes contain the actual Patch/Performance settings.

- All parameters are in 8 bit format, 2s complement (=signed). Each Byte is Nybbleized and coded into two MIDI bytes, with the low Nybble transmitted first.
- A Patch contains 66 parameters, which means the data block of a Patch Dump is transmitted in 132 (66*2) Bytes. See the “Patch Dump Format” table, below.
- A Performance consists of five blocks. The first four blocks contains the four Patches (A to D) This block is 528 MIDI Bytes (4*66*2). After this follows 180 (90*2) of data for parameters local to the Performance. See the “Performance Data Format” table, on [page 112](#).

PATCH DUMP FORMAT

<i>Size</i>	<i>Offset</i>	<i>Name</i>	<i>Min</i>	<i>Max</i>	<i>Comment</i>
1	0	osc2pitch	0	120	middle=60
1	1	osc2pitchfine	0	127	
1	2	mix	0	127	
1	3	cutoff	0	127	
1	4	resonance	0	127	
1	5	filterenvamt	0	127	
1	6	pw	0	127	
1	7	fmdepth	0	127	
1	8	filterenvattack	0	127	
1	9	filterenvdecay	0	127	
1	10	filterenvsustain	0	127	
1	11	filterenvrelease	0	127	
1	12	ampenvattack	0	127	
1	13	ampenvdecay	0	127	
1	14	ampenvsustain	0	127	
1	15	ampenvrelease	0	127	
1	16	portamento	0	127	
1	17	gain	0	127	
1	18	modenvattack	0	127	
1	19	modenvdecay	0	127	
1	20	modenvlevel	0	127	middle=64
1	21	lfo1rate	0	127	
1	22	lfo1level	0	127	
1	23	lfo2rate	0	127	
1	24	arprange	0	127	
1	25	osc2pitch_sens	-128	127	velocity/morf sens
1	26	osc2pitchfine_sens	-128	127	0=OFF
1	27	mix_sens	-128	127	
1	28	cutoff_sens	-128	127	
1	29	resonance_sens	-128	127	
1	30	filterenvamt_sens	-128	127	
1	31	pw_sens	-128	127	
1	32	fmdepth_sens	-128	127	
1	33	filterenvattack_sens	-128	127	
1	34	filterenvdecay_sens	-128	127	
1	35	filterenvsustain_sens	-128	127	
1	36	filterenvrelease_sens	-128	127	
1	37	ampenvattack_sens	-128	127	
1	38	ampenvdecay_sens	-128	127	
1	39	ampenvsustain_sens	-128	127	
1	40	ampenvrelease_sens	-128	127	
1	41	portamento_sens	-128	127	
1	42	gain_sens	-128	127	
1	43	modenvattack_sens	-128	127	
1	44	modenvdecay_sens	-128	127	
1	45	modenvlevel_sens	-128	127	
1	46	lfo1rate_sens	-128	127	
1	47	lfo1level_sens	-128	127	
1	48	lfo2rate_sens	-128	127	
1	49	arprange_sens	-128	127	
1	50	osc1waveform	0	3	3=sine
1	51	osc2waveform	0	3	3=noise
1	52	sync/ringmod/distortion	bit 0 = sync on/off, bit 1 = ring mod on/off, bit 4 = filter dist on/off		
1	53	filtertype	0	4	
1	54	osc2kbdtrack	0	1	

<i>Size</i>	<i>Offset</i>	<i>Name</i>	<i>Min</i>	<i>Max</i>	<i>Comment</i>
1	55	filterkbdtrack	0	3	
1	56	lfo1wave	0	4	
1	57	lfo1dest	0	4	
1	58	voicemode	0	2	
1	59	modwheeldest	0	4	
1	60	unison	0	1	
1	61	modenvdest	0	3	
1	62	auto	0	1	
1	63	filtervel	0	1	
1	64	octshift	0	4	
1	65	lfo2dest/arpmode	0	8	8 = off

For Percussion Kit Sys Ex Dumps, the above parameters will be repeated eight times, once for each sound in the Percussion Kit.

PERFORMANCE DATA FORMAT

<i>Size</i>	<i>Offset</i>	<i>Name</i>	<i>Min</i>	<i>Max</i>	<i>Comment</i>
264	0	"performance_patch [A,B,C,D]"			see PATCH data format
4	264	"midichan [A,B,C,D]"	0	15	
4	268	"lfo1sync [A,B,C,D]"	0	7	
4	272	"lfo2sync [A,B,C,D]"	0	7	
4	276	"filterenvtrig [A,B,C,D]"	0	1	
4	280	"filterenvtrigmidichan [A,B,C,D]"	0	15	
4	284	"filterenvtrignotenr [A,B,C,D]"	23	127	23=off
4	288	"ampenvtrig [A,B,C,D]"	0	1	
4	292	"ampenvtrigmidichan [A,B,C,D]"	0	15	
4	296	"ampenvtrignotenr [A,B,C,D]"	23	127	23=off
4	300	"morftrig [A,B,C,D]"	0	1	
4	304	"morftrigmidichan [A,B,C,D]"	0	15	
4	308	"morftrignotenr [A,B,C,D]"	23	127	23=off
1	312	bendrange	0	8	
1	313	unisondetune	0	8	
1	314	outmode[cd]+ outmode[ab]	0	3	Upper nybble = mode for output c/d
1	315	globalmidichan	0	15	not received!!!
1	316	midiprochange	0	1	not received!!!
1	317	midicntrl	0	1	not received!!!
1	318	mastertune	-99	99	not received!!!
1	319	pedaltype	0	2	not received!!!
1	320	localcontrol	0	1	not received!!!
1	321	Keyboard Octave Shift	0	4	not received!!!
1	322	selected_channel	0	3	
1	323	Arpeggio MIDI Out	0	1	not received!!!
4	324	"channel_activated [A,B,C,D]"	0	1	
4	328	"pgmselect [A,B,C,D]"	0	98	
4	332	"bankselect [A,B,C,D]"	0	3	
4	336	channel pressure amt. [A,B,C,D]	0	7	
4	340	channel pressure dest. [A,B,C,D]	0	4	
4	344	expression pedal amt. [A,B,C,D]	0	7	
4	348	expression pedal dest. [A,B,C,D]	0	4	
1	352	keyboard split	0	1	
1	353	splitpoint	0	127	

MIDI IMPLEMENTATION CHART

Model: Clavia Nord Lead 2X (Keyboard and Rack)

Date: 2003-04-01

Function		Transmitted	Recognized	Remarks
Basic Channel	Default Channel	1 – 16 1 – 16	1 – 16 1 – 16	
Mode	Default Messages Altered	Mode 3 X *****	Mode 3 X	
Note Number	True Voice	0 – 127 *****	0 – 127 0 – 127	
Velocity	Note ON Note OFF	O v = 1 – 127 X	O v = 1 – 127 X	
After Touch	Key's Ch's	X X	X O	
Pitch Bender		O	O	
Control Change		O	O	See the MIDI implementation on page 103 .
Prog Change	True #	O 0 – 109	O 0 – 109	
System Exclusive		O	O	See the MIDI implementation on page 103 .
System Common	: Song Pos : Song Sel : Tune	X X X	X X X	
System Real Time	: Clock : Commands	X X	O X	
Aux Messages	: Local ON/OFF : All Notes Off : Active Sense : Reset	X X X X	X X X X	
Notes				

Mode 1: OMNI ON, POLY
Mode 3: OMNI OFF, POLY

Mode 2: OMNI ON, MONO
Mode 4: OMNI OFF, MONO

O: Yes
X: No

INDEX

A

ADSR envelope
 behavior 46
 Aftertouch 74
 Amount
 LFO 1 54
 LFO 2 56
 Mod Envelope 57
 Amplifier
 Envelope 44
 Introduction to 79
 Triggering Envelope via MIDI 71
 Amplitude Envelope 44
 Arpeggiator 54
 Arpeggio
 Hold 55
 Mode 54
 Range 55
 Speed 54
 Arpeggio to MIDI Out 66
 Attack
 Amplifier 45
 Filter 52
 Introduction to 90
 Mod Envelope 57
 Auto (Portamento) 60

B

Band Reject 49
 Bandpass 49
 Bank Select 76
 BP 49
 Bulk Dump 78

C

carrier (FM) 41
 Control Pedal 19
 control pedal
 technical requirements 9
 Controllers
 Activating transmission/reception 66

Front panel list 103
 MIDI Transmission and reception 74
 Recording in Sequencer 77
 Copying Programs 23

D

Decay
 Amplifier 45
 Filter 52
 Introduction to 91
 Mod Envelope 57
 Demo Play 10
 Destination
 LFO 1 53
 LFO 2 56
 Mod Envelope 57
 Distortion 52
 Drum Kits
 Copying Sounds To and From 30
 Editing 29
 Playing 28
 Selecting 28
 Dump One/All 78

E

Echo 55
 Envelope
 Amplifier 44
 Filter Amount 51
 Introduction to 80
 Expression Pedal 19
 expression pedal
 technical requirements 9

F

Filter
 Introduction to 79, 85
 Triggering Envelope via MIDI 69
 Type 48
 Velocity 24
 Fine Tune 41
 FM Amount 41
 Frequency (Filter) 49
 Frequency Modulation 41

G

Gain 47

H

Highpass 48, 86
 Hold 55
 HP 24dB 48

I

Internet 7

K

Kbd Track (Keyboard Tracking)
 Filter 51
 Osc 2 41
 Keyboard Split 15

L

Layering 14
 Layers
 Playing via MIDI 76
 Legato 59
 LFO 1 52
 LFO 1, Synchronizing to MIDI Clock 68
 LFO 2 54
 LFO 2, Synchronizing to MIDI Clock 69
 LFO, Introduction to 80
 Local (Control) 66
 Lowpass 48, 86
 LP 48
 LP 12dB 48
 LP 24 dB 48

M

Manual 22
 Master Tune 18
 MIDI 66
 MIDI Channel
 Global 67, 76
 Program Slot 67
 With Sequencer 76
 MIDI Connections 76
 Modulation Envelope 57
 Modulation wheel
 Destination 59
 Morphing From 27
 Using 18
 modulator (FM) 41
 Mono

Mode 17, 59
 Out Mode 64
 Output 17
 Morphing 27, 59

N

Noise 39
 Noise Colour 39
 Notch+LP 49

O

Octave Shift 61
 Oscillator
 waveforms
 pulse and square wave 38
 sawtooth wave 38
 sine wave 37
 triangle wave 37
 Oscillator 1 37
 Oscillator 2 39
 Oscillators, Introduction to 79
 Out Mode 17, 64

P

pdf file (reading the manual as...) 7
 Pedal
 Connecting 9
 Morphing 27
 Performances
 Defined 36
 Editing 33
 Introduction to 32
 MIDI Transmission and reception 76
 Recalling 16, 32
 Saving 34
 Pitch Bend, see Pitch Stick
 Pitch Stick
 MIDI Transmission and reception 74
 Range 18
 Using 18
 Poly 17, 59
 Portamento 60
 Prog/Ctrl 66
 Program Change
 Activating transmission/reception 66
 Described 75
 Recording in Sequencer 77

Program Slots

- Introduction to 12

Programs

- Copying 23

- Editing 22

- Layering 14

- MIDI Channel 75

- MIDI Transmission and reception 75

- Selecting 12

- Selecting in a Performance 33

- Storing 23

- Pulse Width 44

R

Rate

- LFO 1 53

- LFO 2 56

Release

- Amplifier 46

- Filter 52

- Introduction to 92

- Resonance 50

- Ring Modulation 42

S

- Semitones 41

- Shift Functions 62

- Special Functions 67

- Split 15

Stereo

- Out Mode 64

Store

- Performance 34

- Program 23

Sustain

- Amplifier 46

- Filter 52

- Introduction to 91

- Sustain Pedal 19

- Sync 43, 84

- System 73

System Exclusive

- Bulk Dump 78

- Implementation 105

T

- Trig button 12

- Tune 18, 64

- Tune (Ring Mod) 42

U

- Unison 60

- Unison Detune 73

V

Velocity

- Morph via MIDI 71

- Programming 24

- to Filter 51

W

Waveform

- LFO 1 53

- Osc 1 37

- Osc 2 39